

**RESOLUTION NO. 809-20**

**A RESOLUTION OF THE TOWN OF BENNETT APPROVING THE  
AMENDED AND RESTATED SERVICE PLAN FOR MUEGGE FARMS  
METROPOLITAN DISTRICT NOS. 1, 2, 3 AND 4**

**WHEREAS**, the Town of Bennett (the “**Town**”), pursuant to Section 32-1-101, *et seq.* of the Colorado Revised Statutes (the “**Special District Act**”), has the authority to approve service plans for metropolitan districts that are organized within the Town’s boundaries; and

**WHEREAS**, along with the Special District Act, Chapter 16, Article XX of the Town of Bennett Municipal Code (the “**Special District Code**”) currently governs the formation of Districts within the Town; and

**WHEREAS**, on August 28, 2018, the Town previously approved the Service Plan for Muegge Farms Metropolitan District Nos. 1, 2, 3 and 4 (the “**Original Service Plan**”); and

**WHEREAS**, no development has occurred within Muegge Farms Metropolitan District Nos. 1, 2, 3 and 4 (collectively, the “**Districts**”) or the Districts’ Service Area since approval of the Original Service Plan; and

**WHEREAS**, a copy of the proposed Amended and Restated Service Plan for Muegge Farms Metropolitan District Nos. 1, 2, 3 and 4 is attached hereto as **Exhibit 1** and incorporated herein by reference (the. “**Amended Service Plan**”); and

**WHEREAS**, the amendments contained in the Amended Service Plan are necessary to incorporate provisions consistent with current development plans and assumptions; and

**WHEREAS**, notice of the public hearing before the Town Board of Trustees (the “**Town Board**”) for its consideration of the Amended Service Plan was duly published in the *Eastern Colorado News* on February 28, 2020, in accordance with the Special District Act, as evidenced by the Affidavit of Publication attached hereto as **Exhibit 2** and incorporated herein by reference; and

**WHEREAS**, in accordance with the Special District Act, notice of the hearing before the Town Board was duly mailed by first class mail on February 28, 2020 to all property owners within the boundaries of the Districts, as evidenced by the Certificate of Mailing of Notice of Hearing to Property Owners attached hereto as **Exhibit 3** and incorporated herein by reference; and

**WHEREAS**, in accordance with the Special District Act, notice of the hearing before the Town Board was also duly mailed by first class mail on February 28, 2020 to interested persons, defined as follows: (1) the Colorado Division of Local Government; and (2) the governing body of any municipality or special district which has levied an ad valorem tax within the next preceding tax year, and which has boundaries within a radius of three miles of the Districts’ boundaries, as evidenced by the Certificate of Mailing of Notice of Hearing to Three Mile Radius parties, attached hereto as **Exhibit 4** and incorporated herein by reference; and

**WHEREAS**, the boundaries of the Districts are wholly contained within the boundaries of the Town; and

**WHEREAS**, pursuant to the provisions of the Special District Act, the Town Board held a public hearing on the Amended Service Plan for the Districts on March 24, 2020; and

**WHEREAS**, the Town Board considered the Amended Service Plan, and all other testimony and evidence presented at said hearing.

**NOW, THEREFORE, BE IT RESOLVED BY THE BOARD OF TRUSTEES OF THE TOWN OF BENNETT, COLORADO, AS FOLLOWS:**

**Section 1.** The hearing before the Town Board was open to the public; all interested parties were heard or had the opportunity to be heard; and all relevant testimony and evidence submitted to the Town Board was considered.

**Section 2.** The Town Board hereby determines that the requirements of Sections 32-1-204 (l) and (1.5), C.R.S., relating to notice of the hearing by the Town Board, and Section 32-1-204.5, C.R.S., relating to the approval by the Town Board, have been fulfilled.

**Section 3.** Evidence satisfactory to the Town Board for finding each of the following was presented at the hearing:

- a. there is sufficient existing and projected need for organized service in the area to be served by the Districts;
- b. the existing service in the area to be served by the Districts is inadequate for present and projected needs;
- c. the Districts are capable of providing economical and sufficient service to the area within their proposed boundaries; and
- d. the area to be included within the Districts has, or will have, the financial ability to discharge the proposed indebtedness on a reasonable basis.

**Section 4.** The Town Board hereby finds that approval of the Amended Service Plan is in the best interests of the property to be served, the Town and the Districts.

**Section 5.** The Town Board hereby approves the Amended Service Plan for the Districts as submitted.

**Section 6.** A certified copy of this Resolution shall be filed in the records of the Town and the Adams County Clerk and Recorder, and submitted to the petitioners under the Amended Service Plan for the purpose of filing in the District Court of Adams County.

**Section 7.** That the Town Board's findings in this Resolution and its approval of the Amended Service Plan are conditioned upon the proponents of the Amended Service Plan having

reimbursed the Town for all the charges and fees it has incurred with its consultants relating to their review of the Amended Service Plan and creation of the Districts.

**Section 8.** That nothing herein limits the Town's powers with respect to the Districts, the property within the Districts, or the improvements to be constructed by the Districts.

**Section 9.** That the Town's findings are based solely on the evidence in the Amended Service Plan and such other evidence presented at the public hearing, and the Town has not conducted any independent investigation of the evidence. The Town makes no guarantee as to the financial viability of the Districts or the achievability of the results as set forth in the Amended Service Plan.

**Section 10.** That this Resolution shall be effective as of the date of its adoption.

**INTRODUCED, READ AND ADOPTED THIS 24<sup>th</sup> DAY OF MARCH, 2020.**

**TOWN OF BENNETT**



---

Royce D. Pindell, Mayor

ATTEST:

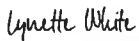

---

Lynette F. White  
Town Clerk

**EXHIBIT 1**

**Amended and Restated Service Plan for Muegge Farms Metropolitan District Nos. 1, 2, 3  
and 4**

The Amended and Restated Service Plan for Muegge Farms Metropolitan District Nos. 1, 2, 3 and 4 is on file and available for review at the office of the Town of Bennett Town Clerk and the Adams County Clerk and Recorder.

**AMENDED AND RESTATED SERVICE PLAN  
FOR  
MUEGGE FARMS METROPOLITAN DISTRICT NOS. 1, 2, 3 AND 4  
TOWN OF BENNETT, COLORADO**

Prepared

by

McGeady Becher P.C.  
450 East 17th Avenue, Suite 400  
Denver, CO 80203

Submitted: March 3, 2020

Approved: March 24, 2020

m m m  
Initials

TABLE OF CONTENTS

	<u>Page</u>
<b>I. INTRODUCTION .....</b>	<b>1</b>
A. Purpose and Intent. ....	1
B. Need for the Districts. ....	1
C. Objective of the Town Regarding the Service Plan.....	1
D. Organizers and Consultants. ....	2
<b>II. DEFINITIONS.....</b>	<b>3</b>
<b>III. BOUNDARIES.....</b>	<b>7</b>
<b>IV. PROPOSED LAND USE, PROJECTED POPULATION PROJECTIONS AND CURRENT ASSESSED VALUATION .....</b>	<b>8</b>
<b>V. DESCRIPTION OF PROPOSED POWERS, IMPROVEMENTS AND SERVICES.. .....</b>	<b>8</b>
A. Powers of the Districts and Service Plan Amendment. ....	8
1. Operation and Maintenance Limitation .....	8
2. Fire Protection Limitation.....	9
3. Television Relay and Translation Limitation .....	9
4. Limitation on Extraterritorial Service.....	9
5. Telecommunication Facilities.....	9
6. Construction Standards Limitation .....	9
7. Zoning and Land Use Requirements .....	9
8. Growth Limitations.....	9
9. Conveyance.....	9
10. Eminent Domain.....	10
11. Water Rights/Resources Limitation.....	10
12. Inclusion Limitation.....	10

13.	Exclusion Limitation .....	10
14.	Overlap Limitation.....	10
15.	Sales and Use Tax.....	10
16.	Monies from Other Governmental Sources.....	10
17.	Consolidation Limitation .....	10
18.	Subdistrict Limitation.....	10
19.	Fees .....	10
20.	Special Assessments .....	11
21.	Bankruptcy Limitation.....	11
22.	Cost Recovery.....	11
23.	Service Plan Amendment Requirement.....	11
B.	Preliminary Engineering Survey.....	12
C.	Multiple District Structure.....	12
<b>VI.</b>	<b>REGIONAL IMPROVEMENTS .....</b>	<b>12</b>
A.	General.....	12
B.	BRI Mill Levy.....	13
<b>VII.</b>	<b>FINANCIAL PROVISIONS.....</b>	<b>14</b>
A.	General.....	14
B.	Maximum Voted Interest Rate and Maximum Underwriting Discount. ....	15
C.	Mill Levies.....	15
D.	Debt Parameters.....	16
E.	Debt Instrument Disclosure Requirement. ....	17
F.	Privately Placed Debt Limitation.....	17
G.	TABOR Compliance. ....	17
H.	Districts' Organizational Costs and Operation and Maintenance Costs.....	18

**VIII. ANNUAL REPORT.....18**

    A. General.....18

    B. Reporting of Significant Events.....18

**IX. DISSOLUTION.....19**

**X. DISCLOSURE NOTICES .....19**

**XI. INTERGOVERNMENTAL AGREEMENT .....19**

**XII. CONCLUSION .....19**



**LIST OF EXHIBITS**

<b>EXHIBIT A</b>	Vicinity Map
<b>EXHIBIT B</b>	Initial Boundary Map for District Nos. 1-8, and Inclusion Area Boundary Map
<b>EXHIBIT C-1</b>	Legal Description, Initial Boundaries, District No. 1
<b>EXHIBIT C-2</b>	Legal Description, Initial Boundaries, District No. 2
<b>EXHIBIT C-3</b>	Legal Description, Initial Boundaries, District No. 3
<b>EXHIBIT C-4</b>	Legal Description, Initial Boundaries, District No. 4
<b>EXHIBIT C-5</b>	Inclusion Area Legal Description
<b>EXHIBIT D</b>	Financial Plan
<b>EXHIBIT E</b>	List of Public Improvements and Costs of Public Improvements
<b>EXHIBIT F</b>	Intergovernmental Agreement

## I. INTRODUCTION

### A. Purpose and Intent.

The Districts are independent units of local government, separate and distinct from the Town. The primary purpose of the Districts will be to finance the construction of the Public Improvements. The Districts are not being created to provide ongoing operation and maintenance services other than as specifically set forth in this Service Plan or in the Intergovernmental Agreement between the Town and the Districts.

This multiple-district Amended and Restated Service Plan for Muegge Farms Metropolitan District Nos. 1-4 (“**Service Plan**”) fully amends and supersedes in its entirety the Service Plan for Muegge Farms Metropolitan District Nos. 1-4, approved by the Town on August 28, 2018 (the “**Original Service Plan**”). No development has occurred within the Districts or the Service Area since approval of the Original Service Plan and the amendments contained herein are necessary to incorporate provisions consistent with current development plans and assumptions. This multiple-district Service Plan is intended to accommodate the phasing of the Project and the infrastructure needs of each phase. It is contemplated that the Districts will cooperate with each other on certain infrastructure that benefits the taxpayers and inhabitants of the Service Area, and that each District will additionally have its own particular infrastructure needs.

### B. Need for the Districts.

There are currently no other governmental entities, including the Town, located in the immediate vicinity of the Districts that consider it desirable, feasible or practical to undertake the planning, design, acquisition, construction, installation, relocation, redevelopment, and financing of the Public Improvements needed for the Project. The Districts are therefore necessary to provide the Public Improvements required for the Project in the most economic manner possible.

### C. Objective of the Town Regarding the Service Plan.

The Town’s objective in approving the Service Plan for the Districts is to authorize the Districts to provide for the planning, design, acquisition, construction, installation, relocation and redevelopment of the Public Improvements from the proceeds of Debt to be issued by the Districts. Except for Debt which is repayable from the BRI Mill Levy, as set forth in Section VI herein, all Debt is expected to be repaid by taxes imposed and collected at a mill levy no higher than the Maximum Debt Mill Levy, as the same may be increased as set forth in Section V.C.1; by Fees as limited by Section V.A.19; and/or by Special Assessments as set forth in Section V.A.20.

This Service Plan is intended to establish a limited purpose for the Districts and explicit financial constraints that are not to be violated under any circumstances. The primary purpose of the Districts is to provide the Public Improvements associated with development pursuant to the Approved Development Plan. Except for the Operation and Maintenance Costs the Districts are authorized to pay in accordance with Section VII.H herein, operation and maintenance services are allowed only through the Intergovernmental Agreement with the Town.

Each District shall dissolve upon payment or defeasance of all Debt incurred or upon a court determination that adequate provision has been made for the payment of all Debt, except that if the District has ongoing operation and maintenance functions authorized under an Intergovernmental Agreement with the Town, the District shall not be required to dissolve but shall retain only the power necessary to impose and collect taxes (subject to the Maximum Operation and Maintenance Mill Levy), Special Assessments or Fees in amounts necessary to pay for those Operation and Maintenance Costs. Additionally, if the Board of Directors of a District determines that the existence of that District is no longer necessary to accomplish the purposes set forth in this Service Plan, the Board of Directors of that District shall promptly effectuate the dissolution of that District.

The Districts shall be authorized to finance the Public Improvements that can be funded from Debt which is to be repaid from Fees, Special Assessments or tax revenues collected from a mill levy which shall not exceed the Maximum Debt Mill Levy, as well as other legally available sources of revenue, and to maintain certain of the Public Improvements as set forth in the Intergovernmental Agreement with the Town. It is the intent of this Service Plan to assure to the extent possible that no property bear an economic burden that is greater than that associated with revenues from the Maximum Debt Mill Levy, the Maximum Operation and Maintenance Mill Levy, Fees and Special Assessments, even under bankruptcy or other unusual situations. Generally, the costs of Public Improvements that cannot be funded within these parameters are not costs to be paid by the Districts.

With regard to Regional Improvements, this Service Plan also provides for the Districts to pay a portion of the cost of regional infrastructure as part of ensuring that development and those that benefit from development pay for the associated costs.

D. Organizers and Consultants.

This Service Plan has been prepared by the following:

Organizers

MGV Investments, LLC  
P.O. Box 4701  
Greenwood Village, CO 80155-4701  
Phone: (303) 507-6651  
E-mail: jimmarshall@bcxdevelopment.com  
Attn: Jim Marshall

District Counsel

McGeady Becher P.C.  
450 East 17th Avenue, Suite 400  
Denver, CO 80203  
Phone: (303) 592-4380  
E-mail: mmcgeady@specialdistrictlaw.com  
Attn: MaryAnn McGeady

Underwriter

D.A. Davidson & Co.  
1550 Market St., Suite 300  
Denver, CO 80202  
Phone: (303) 764-5724  
E-mail: ssharp@dadco.com  
Attn: Sam Sharp

Engineers

CORE Consultants, Inc.  
1950 W Littleton Blvd, Suite 109  
Littleton CO 80120  
Phone: (303) 730-5992  
E-mail: rohrbough@corecivil.com  
Attn: Kevin Rohrbough

Bond Counsel  
Sherman & Howard LLC  
633 Seventeenth Street, Suite 3000  
Denver, Colorado 80202  
Phone: (303) 297-2900  
E-mail: tleichman@shermanhoward.com  
Attn: Tiffany Leichman

## **II. DEFINITIONS**

In this Service Plan, the following terms shall have the meanings indicated below, unless the context hereof clearly requires otherwise:

Approved Development Plan: means a development plan for the Project as approved in its final form by the Town pursuant to the Town Code, as may be amended from time to time pursuant to the Town Code, that identifies, among other things (1) Public Improvements necessary for facilitating development of the property within the Service Area; and (2) any developer guarantees in connection with development of the property.

Board: means the board of directors of any one of the Districts, as applicable.

BRI: means Bennett Regional Improvements.

BRI Authority: means one or more authorities established by a BRI Establishment Agreement.

BRI Establishment Agreement: means a written agreement establishing a BRI Authority which has, at minimum, Title 32 special districts from three (3) or more Approved Development Plan areas as parties to the BRI Establishment Agreement.

BRI Master Plan: means one or more master plans adopted by a BRI Authority establishing Regional Improvements which will benefit the taxpayers and service users of the Districts which constitute such BRI Authority, which master plan may change from time to time.

BRI Mill Levy: means the following:

A. For districts with property within their boundaries developed or proposed to be developed with any residential uses the mill levy imposed for payment of the costs of the planning, design, permitting, construction, acquisition and financing of the improvements described in the BRI Master Plan, shall be: (i) one and one hundred six thousandths (1.106) mills for collection beginning for each district in the first year of collection of a debt service mill levy by such district and continuing in each year thereafter through the twentieth (20<sup>th</sup>) year; and (ii) five and five hundred twenty eight thousandths (5.528) mills from the twenty-first (21<sup>st</sup>) year through the fortieth (40<sup>th</sup>) year or the date of repayment of the debt incurred for Public Improvements, other than Regional Improvements, which ever first occurs; and (iii) for an additional ten (10) years thereafter, the mill levy shall be equal to the average debt service mill

levy imposed by such district in the ten (10) years prior to the date of repayment of the debt incurred for Public Improvements other than Regional Improvements; and

B. For districts with property within their boundaries developed or proposed to be developed solely for commercial uses the mill levy imposed for payment of the costs of the planning, design, permitting, construction, acquisition and financing of the improvements described in the BRI Master Plan, shall be: (i) one (1) mill for collection beginning for each district in the first year of collection of a debt service mill levy by such district and continuing in each year thereafter through the twentieth (20<sup>th</sup>) year; and (ii) one and one-half (1.5) mills from the twenty-first (21<sup>st</sup>) year through the fortieth (40<sup>th</sup>) year or the date of repayment of the debt incurred for Public Improvements, other than Regional Improvements, which ever first occurs; and (iii) for an additional five (5) years thereafter, the mill levy shall be the lesser of twenty (20) mills or a mill levy equal to the average debt service mill levy imposed by such district in the ten (10) years prior to the date of repayment of the debt incurred for Public Improvements other than Regional Improvements; and

C. Any district may, pursuant to written agreement with the Town, extend the term for application of the BRI Mill Levy beyond the years set forth in A and B above; and

D. All mills described in this BRI Mill Levy definition shall be subject to the Mill Levy Adjustment.

C.R.S. means the Colorado Revised Statutes, as the same may be amended from time to time.

Debt: means bonds, notes, debentures, certificates, contracts, capital leases or other multiple fiscal year obligations for the payment of which any of the Districts have promised to impose an ad valorem property tax mill levy, collect Fee revenue, and/or levy Special Assessments.

District: means any one of the Districts.

District No. 1: means Muegge Farms Metropolitan District No. 1.

District No. 2: means Muegge Farms Metropolitan District No. 2.

District No. 3: means Muegge Farms Metropolitan District No. 3.

District No. 4: means Muegge Farms Metropolitan District No. 4.

Districts: means District Nos. 1, 2, 3, and 4, collectively.

District Boundaries: means the property within any of the Districts' Initial Boundaries, together with the property within any of the Initial Boundaries of Muegge Farms Metropolitan District Nos. 5, 6, 7, and 8, and together with any portion of the property within the Inclusion Area Boundaries, that may be included and excluded between and among the Districts and Muegge Farms Metropolitan District Nos. 5, 6, 7 and 8, from time to time pursuant to Section 32-1-401, *et seq.*, and Section 32-1-501, *et seq.*, C.R.S.

End User: means any owner, or tenant of any owner, of any taxable improvement within a District who is intended to become burdened by the imposition of ad valorem property taxes subject to the Maximum Debt Mill Levy. By way of illustration, a resident homeowner, renter, commercial property owner, or commercial tenant is an End User. A person or entity that constructs homes or commercial structures with the intention of selling to others is not an End User.

External Financial Advisor: means a consultant that: (i) advises Colorado governmental entities on matters relating to the issuance of securities by Colorado governmental entities, including matters such as the pricing, sales and marketing of such securities and the procuring of bond ratings, credit enhancement and insurance in respect of such securities; (ii) shall be an underwriter, investment banker, or individual listed as a public finance advisor in the Bond Buyer's Municipal Market Place; and (iii) is not an officer or employee of any of the Districts and has not been otherwise engaged to provide services in connection with the transaction related to the applicable Debt. If a District has engaged a municipal adviser that meets the foregoing criteria and has a fiduciary duty to the District, the municipal adviser may fill the role of the External Financial Advisor.

Fees: means any fee, rate, toll, penalty or charge imposed or received by a District for services, programs or facilities provided by that District, as described in Section V.A.19 below.

Financial Plan: means the Financial Plan described in Section VII and attached as **Exhibit D** which describes (i) how the Public Improvements are expected to be financed; (ii) how the Debt is expected to be incurred; and (iii) the estimated operating revenue derived from property taxes for the first budget year.

Inclusion Area Boundaries: means the Initial Boundaries of the Districts, the Initial Boundaries of Muegge Farms Metropolitan District Nos. 5, 6, 7, and 8, and the Inclusion Area as shown on the Inclusion Area Boundary Map, attached as **Exhibit B**. The legal description for the Inclusion Area is described in the Inclusion Area Legal Description, attached hereto as **Exhibit C-5**. The areas within the Inclusion Area Boundaries are contained within the Project as outlined in the Approved Development Plan.

Initial Boundaries: means the boundaries of each District's area described in the Initial Boundary Map, attached as **Exhibit B**, and the respective Legal Descriptions, attached hereto as **Exhibit C-1** (for District No. 1), **Exhibit C-2** (for District No. 2), **Exhibit C-3** (for District No. 3), and **Exhibit C-4** (for District No. 4).

Intergovernmental Agreement: means the amended and restated intergovernmental agreement between the Districts and the Town, a form of which is attached hereto as **Exhibit F**. The Intergovernmental Agreement may be amended from time to time by the Districts and the Town.

Maximum Debt Mill Levy: means, for each District, the maximum mill levy the District is permitted to impose for payment of Debt as set forth in Section VII.C.1 below. The Maximum Debt Mill Levy does not include the BRI Mill Levy.

Maximum Operation and Maintenance Mill Levy: means, for each District, the maximum mill levy the District is permitted to impose for payment of Operation and Maintenance Costs, as set forth in Section VII.C.2 below.

Maximum Aggregate Mill Levy: means, for each District, the maximum combined mill levy the District is permitted to impose upon the taxable property within the District for payment of all expenses categories, including, but limited to, Debt, capital costs, organizational costs, and Operation and Maintenance Costs, except that the Maximum Aggregate Mill Levy shall not include the BRI Mill Levy. The Maximum Aggregate Mill Levy is set forth in Section VII.C.3 below.

Mill Levy Adjustment: means, if, on or after January 1, 2018, there are changes in the method of calculating assessed valuation or any constitutionally mandated tax credit, cut or abatement, the Maximum Debt Mill Levy, the Maximum Operation and Maintenance Mill Levy, and the BRI Mill Levy may be increased or decreased to reflect such changes, such increases and decreases to be determined by the Board in good faith (such determination to be binding and final) so that to the extent possible, the actual tax revenues generated by the applicable mill levy, as adjusted for changes occurring after January 1, 2018, are neither diminished nor enhanced as a result of such changes. For purposes of the foregoing, a change in the ratio of actual valuation shall be deemed to be a change in the method of calculating assessed valuation.

Operation and Maintenance Costs: means, for each District: (1) planning and design costs of Public Improvements identified by the District as being payable from its operation and maintenance mill levy; (2) the costs of repair, replacement and depreciation of the Public Improvements; (3) the costs of any covenant enforcement and design review services the District may provide; and (4) the costs of ongoing administrative, accounting and legal services to the District.

Organizational Costs: means the estimated initial cost of acquiring land, engineering services, legal services and administrative services, together with the estimated costs of the Districts' organization and initial operations, as set forth in Section VII.H below, which Organizational Costs are eligible for reimbursement out of Debt proceeds.

Project: means the development or property commonly referred to as Muegge Farms.

Public Improvements: means a part or all of the improvements authorized to be planned, designed, acquired, constructed, installed, relocated, redeveloped and financed by the Districts or Muegge Farms Metropolitan District Nos. 5, 6, 7, or 8, as generally described in the Special District Act and in accordance with the Approved Development Plan, except as specifically limited in Section V below, which improvements benefit the property within the District Boundaries and/or the Service Area, and which improvements will serve the future taxpayers and inhabitants of the property within the District Boundaries and/or the Service Area, as determined by the Boards of the Districts or the Boards of Muegge Farms Metropolitan District Nos. 5, 6, 7, or 8.

Regional Improvements: means improvements or facilities that benefit the property within the District Boundaries and/or the Service Area and which are to be financed pursuant to Section VI below.

Service Area: means the Initial Boundaries and the Inclusion Area Boundaries.

Service Plan: means this amended and restated service plan for the Districts approved by the Town Board.

Service Plan Amendment: means an amendment to the Service Plan approved by the Town Board in accordance with the Town's ordinance and the applicable state law.

Special Assessment: means the levy of an assessment within the boundaries of a special improvement district pursuant to Section V.A.20 below.

Special District Act: means Title 32, Article 1 of the Colorado Revised Statutes, as amended from time to time.

State: means the State of Colorado.

Taxable Property: means real or personal property which is subject to ad valorem taxes imposed by a District.

Town: means the Town of Bennett, Colorado.

Town Board: means the Town Board of Trustees of the Town of Bennett, Colorado.

Town Code: means the Town Code of the Town of Bennett, Colorado.

Total Debt Limit: means Three Hundred Sixty Million Dollars (\$360,000,000), which Total Debt Limit includes all Debt issued by any of the Districts and by Muegge Farms Metropolitan District Nos. 5, 6, 7, or 8, in the aggregate, for Public Improvements and Regional Improvements.

### **III. BOUNDARIES**

A Vicinity Map depicting the Project is attached hereto as **Exhibit A**. The area of the Initial Boundaries for each District is approximately 5,041 square feet, or 0.116 acre, respectively, and the maps of the Initial Boundaries for each of the Districts are set forth in **Exhibit B**. The legal descriptions for each District's Initial Boundaries are set forth in **Exhibit C-1, Exhibit C-2, Exhibit C-3, and Exhibit C-4**, respectively. The Inclusion Area Boundary Map as depicted on **Exhibit B** depicts the property to be included within the Districts or within Muegge Farms Metropolitan District Nos. 5, 6, 7, or 8, the Legal Description for the Inclusion Area is set forth in **Exhibit C-5**, and includes approximately Four-Hundred Twenty-Three and Sixty-Seven One Hundredths (423.67) acres. It is anticipated that the Districts' boundaries may change from time to time as they undergo inclusions and exclusions pursuant to Section 32-1-



401, *et seq.*, C.R.S., and Section 32-1-501, *et seq.*, C.R.S., subject to the limitations set forth in Section V below.

**IV. PROPOSED LAND USE, PROJECTED POPULATION PROJECTIONS AND CURRENT ASSESSED VALUATION**

The property within the Service Area consists of approximately Four-Hundred Twenty-Three and Eight-Hundred Twenty-Eight Thousandths (423.828) acres of land zoned as PD – Planned Development, which is planned to be developed for residential use. The Project is anticipated to consist of approximately Two Thousand Eight Hundred Three (2,803) residential units, and the population of the Service Area at build-out is estimated to be approximately Five Thousand (5,000) people. The current assessed valuation of the property within the Service Area is Zero Dollars (\$0.00) for purposes of this Service Plan, and the assessed value of the property within the Service Area at build-out is expected to be sufficient to reasonably discharge the Debt under the Financial Plan attached hereto as **Exhibit D**.

Approval of this Service Plan by the Town does not imply approval of the development of a specific area within the Service Area, nor does it imply approval of the number of residential units or the total site/floor area of commercial or industrial buildings identified in this Service Plan or any of the exhibits attached thereto, which approvals shall be as set forth in an Approved Development Plan. The approval of this Service Plan by the Town in no way relieves the developer of any of the property within the Service Area of any developer guarantees or other conditions, requirements or commitments as set forth in the applicable Approved Development Plan or required by the Town Code.

**V. DESCRIPTION OF PROPOSED POWERS, IMPROVEMENTS AND SERVICES**

**A. Powers of the Districts and Service Plan Amendment.**

The Districts shall have the power and authority to provide the Public Improvements and related operation and maintenance services as such power and authority is described in the Special District Act and other applicable statutes, common law, and the Constitution, subject to the limitations set forth herein, in the Approved Development Plan, and in the Intergovernmental Agreement.

1. **Operation and Maintenance Limitation.** The purpose of the Districts is to plan for, design, acquire, construct, install, relocate, redevelop and finance the Public Improvements. The Districts shall dedicate the Public Improvements to the Town or other appropriate jurisdiction or owners association in a manner consistent with the Approved Development Plan, the Intergovernmental Agreement, and other rules and regulations of the Town and applicable provisions of the Town Code. Except for park and recreation improvements, no District shall be authorized to operate and maintain any part or all of the Public Improvements unless the provision of such operation and maintenance is pursuant to the Intergovernmental Agreement with the Town. Unless otherwise specified in the Intergovernmental Agreement, all parks and trails shall be open to the general public free of charge. The Districts may impose a mill levy, Special Assessments and/or Fees to pay for Operation and Maintenance Costs in accordance with Section VII.H below. The Districts have

the power to provide ongoing covenant enforcement and design review services in accordance with the Special District Act as part of its operation and maintenance activities.

2. Fire Protection Limitation The Districts shall not be authorized to plan for, design, acquire, construct, install, relocate, redevelop, finance, operate or maintain fire protection facilities or services, unless such facilities and services are provided pursuant to a written agreement with the Town and with Bennett Fire Protection District. The authority to plan for, design, acquire, construct, install, relocate, redevelop or finance fire hydrants and related improvements installed as part of the water system shall not be limited by this provision.

3. Television Relay and Translation Limitation. The Districts shall not be authorized to plan for, design, acquire, construct, install, relocate, redevelop, finance, operate or maintain television relay and translation facilities and services, other than for the installation of conduit as a part of a street construction project, unless such facilities and services are provided pursuant to the Intergovernmental Agreement.

4. Limitation on Extraterritorial Service. The Districts shall be authorized to provide services or facilities outside the Service Area or to establish fees, rates, tolls, penalties or charges for any services or facilities only in accordance with an Approved Development Plan, the Intergovernmental Agreement, or other agreement to which the Town is a party or otherwise gives its written consent.

5. Telecommunication Facilities. The Districts agree that no telecommunication facilities shall be constructed except pursuant to the Intergovernmental Agreement and that no such facilities owned, operated or otherwise allowed by the Districts shall affect the ability of the Town to expand its public safety telecommunication facilities or impair existing telecommunication facilities.

6. Construction Standards Limitation. The Districts will ensure that the Public Improvements are designed and constructed in accordance with the standards and specifications of the Town and of other governmental entities having proper jurisdiction. The Districts will obtain the approval of civil engineering plans from the appropriate jurisdiction and will obtain applicable permits for construction and installation of Public Improvements prior to performing such work.

7. Zoning and Land Use Requirements. The Districts shall be subject to all of the Town's zoning, subdivision, building code and other land use requirements.

8. Growth Limitations. The Town shall not be limited in implementing Board or voter approved growth limitations, even though such actions may reduce or delay development within the Districts and the realization of District revenue.

9. Conveyance. The Districts agree to convey to the Town, upon written notification from the Town and at no cost to the Town, any interest in real property owned by any District that is necessary, in the Town's sole discretion, for any Town capital improvement projects for transportation, utilities or drainage, so long as such conveyance does not interfere with the District's ability to construct, operate and/or maintain Public Infrastructure, as the same may be limited by this Service Plan.

10. Eminent Domain. The Districts shall be authorized to utilize the power of eminent domain only in accordance with the Intergovernmental Agreement. In the event the limit on the Districts' ability to exercise the power of eminent domain inhibits the Districts' ability to issue debt, or will cause the interest on any Debt issued by the Districts to be included in gross income for federal income tax purposes, and the Districts shall have obtained the written opinion of bond counsel with respect to the foregoing, the limit set forth herein or in the Intergovernmental Agreement on the Districts' ability to exercise the power of eminent domain shall be of no further force or effect, and shall be retroactive to the date of the organization of the Districts if the avoidance of the interest on Debt being included in gross income for federal income tax purposes as described in this paragraph so necessitates.

11. Water Rights/Resources Limitation. The Districts shall not acquire, own, manage, adjudicate or develop water rights or resources except as otherwise provided pursuant to the Intergovernmental Agreement.

12. Inclusion Limitation. Without prior written notice to the Town, no District shall include into its boundaries any property. Without the prior consent of the Town, no District shall include any property into its boundaries which is not property within the Inclusion Area Boundaries. No property will be included within any District at any time unless such property has been annexed into the Town's corporate limits.

13. Exclusion Limitation. No District shall exclude from its boundaries any property within the District Boundaries without prior written notice to the Town.

14. Overlap Limitation. The boundaries of a District shall not overlap with any other district formed under the Special District Act if such overlap will cause that District's mill levy to exceed the Maximum Debt Mill Levy, the Maximum Operation and Maintenance Mill Levy and/or the Maximum Aggregate Mill Levy.

15. Sales and Use Tax. The Districts shall not exercise the Town sales and use tax exemption.

16. Monies from Other Governmental Sources. The Districts shall not apply for or accept Conservation Trust Funds, Great Outdoors Colorado Funds, or other funds available from or through governmental or non-profit entities that the Town is eligible to apply for, except pursuant to the Intergovernmental Agreement. This Section shall not apply to specific ownership taxes which shall be distributed to and be a revenue source for the Districts without any limitation.

17. Consolidation Limitation. No District shall file a request with any Court to consolidate with another Title 32 district without the prior written consent of the Town, unless such consolidation is with one of the other Districts to which this Service Plan applies.

18. Subdistrict Limitation. No District shall create any subdistrict pursuant to Section 32-1-1101, C.R.S., without the prior written consent of the Town.

19. Fees. A District may impose and collect Fees for services, programs or facilities furnished by that District, and a District may from time to time increase or decrease its

Fees. A District may use the revenue from Fees for the payment of Operation and Maintenance Costs and for the payment of any indebtedness of that District.

20. Special Assessments. If authorized in the Intergovernmental Agreement, a District may establish one or more special improvement districts within its District Boundaries and may levy a Special Assessment with the special improvement district in order to finance all or part of the costs of any Public Improvements to be constructed or installed that the District is authorized to finance.

21. Bankruptcy Limitation. All of the limitations contained in this Service Plan, including, but not limited to, those pertaining to the Maximum Aggregate Mill Levy, the Maximum Debt Mill Levy, the Maximum Operation and Maintenance Mill Levy, and Fees have been established under the authority of the Town to approve a Service Plan pursuant to Section 32-1-204.5, C.R.S. It is expressly intended that such limitations:

(a) Shall not be subject to set-aside for any reason or by any court of competent jurisdiction, absent a Service Plan Amendment; and

(b) Are, together with all other requirements of Colorado law, included in the “political or governmental powers” reserved to the State under the U.S. Bankruptcy Code (11 U.S.C.) Section 903, and are also included in the “regulatory or electoral approval necessary under applicable nonbankruptcy law” as required for confirmation of a Chapter 9 Bankruptcy Plan under Bankruptcy Code Section 943(b)(6).

The filing of any bankruptcy petition by any District shall constitute, simultaneously with such filing, a material departure of the express terms of this Service Plan, thus necessitating a material modification that must be submitted to the Town for its consideration as a Service Plan Amendment.

22. Cost Recovery. If a cost-recovery agreement exists or is entered into for an improvement financed by any of the Districts, any and all resulting reimbursements received for such improvement shall be deposited in the Districts’ debt service fund and used for the purpose of retiring that District’s Debt. To the extent an advance from a developer was used to finance all or part of the improvement, the resulting reimbursements may be used to reimburse that developer for the amounts so advanced; provided, however, that once such developer has been reimbursed in full for amounts advanced in constructing the improvement, any and all remaining reimbursements shall be deposited in the Districts’ debt service fund and used for the purpose of retiring that District’s Debt.

23. Service Plan Amendment Requirement. This Service Plan has been designed with sufficient flexibility to enable the Districts to provide required services and facilities under evolving circumstances without the need for numerous amendments. Actions of any District which violates the limitations set forth in V.A. above or in VII.C or VII.D shall be deemed to be material modifications to this Service Plan and the Town shall be entitled to all remedies available under State and local law to enjoin such actions of the District.

B. Preliminary Engineering Survey.

The Districts shall have authority to provide for the planning, design, acquisition, construction, installation, relocation, redevelopment, maintenance, and financing of the Public Improvements. A list of the Public Improvements the Districts and Muegge Farms Metropolitan District Nos. 5, 6, 7, and 8 anticipate providing (except for any anticipated Regional Improvements), including a cost estimate for each category of improvements, is attached hereto as **Exhibit E**. The Districts shall be authorized to construct Public Improvements that shall be more specifically defined in each applicable Approved Development Plan, the Intergovernmental Agreement, or other agreement to which the Town is a party or otherwise gives its written consent. The estimated the costs of the Public Improvements which may be planned for, designed, acquired, constructed, installed, relocated, redeveloped, maintained or financed was prepared based upon a preliminary engineering survey and estimates derived from the zoning on the property in the property within the Service Area and is approximately One Hundred Twenty Two Million Three Hundred Twenty Seven Thousand Five Hundred Ten Dollars (\$122,327,510), which consists of approximately Twenty-Five Million Four Hundred Thirty-Seven Thousand Eight Hundred Ninety Dollars (\$25,437,890) in costs of Public Improvements for District No. 1, and approximately Ninety-Six Million Eight Hundred Eighty-Nine Thousand Six Hundred Twenty Dollars (\$96,889,620) in costs of Public Improvements for District Nos. 2 through 8.

All of the Public Improvements will be designed in such a way as to assure that the Public Improvements standards will be compatible with those of the Town and shall be in accordance with the requirements of the Approved Development Plan. All construction cost estimates are based on the assumption that construction conforms to applicable local, State or Federal requirements.

C. Multiple District Structure.

It is anticipated that the Districts, collectively, will undertake the financing and construction of certain of the Public Improvements contemplated herein. Specifically, the Districts shall enter into one or more intergovernmental agreements with each other that shall govern the relationships between and among them, or with Muegge Farms Metropolitan District Nos. 5, 6, 7, and 8, with respect to the financing, construction and operation of the Public Improvements. The Districts and Muegge Farms Metropolitan District Nos. 5, 6, 7, and 8 will establish a mechanism whereby any one or more of the Districts or Muegge Farms Metropolitan District Nos. 5, 6, 7, and 8 may separately or collectively fund, construct, install and operate the Public Improvements.

**VI. REGIONAL IMPROVEMENTS**

A. General.

The Districts shall be authorized to provide for the planning, design, acquisition, construction, installation, relocation and/or redevelopment and to contribute to the funding of the Regional Improvements, and to fund the administration and overhead costs related to the provisions of the Regional Improvements incurred as a result of participation in the alternatives

set forth in Section B.1, 2 or 3 below. The Regional Improvements shall be limited to the provision of the planning, design, acquisition, construction, installation, relocation and/or redevelopment of street and transportation related improvements as defined in the Special District Act and the administration and overhead costs incurred as a result of participation in the alternative set forth in Section B.1, 2 or 3 below, unless the Town has agreed otherwise in writing; provided, however, in no event shall the Regional Improvements include water or sanitary sewer improvements unless such improvements are necessary as a part of completing street and transportation related improvements.

B. BRI Mill Levy.

The Districts shall each impose the BRI Mill Levy and shall convey it as follows:

1. If the District has executed a BRI Authority Establishment Agreement and the Town has been offered the opportunity to participate in the BRI Authority Establishment Agreement, the terms of which provide for the Town to appoint no less than thirty percent (30%) and no more than forty-nine percent (49%) of the board members who will serve as the board of directors of the BRI Authority to be established by such BRI Authority Establishment Agreement, regardless as to whether the Town becomes a party to such BRI Authority Establishment Agreement, the revenue from the BRI Mill Levy shall be conveyed to the BRI Authority for the planning, designing, constructing, installing, acquiring, relocating, redeveloping or financing of the Regional Improvements set forth in the BRI Master Plan and for the operations of such BRI Authority; or

2. If the Town and the District have executed an agreement then the revenue from the BRI Mill Levy shall be conveyed to the Town for use in planning, designing, constructing, installing, acquiring, relocating, redeveloping or financing of the Regional Improvements which benefit the service users and taxpayers of the District in accordance with such agreement; or

3. If neither Section B.1 nor B.2 above is applicable then the revenue shall be conveyed to the Town and (i) the Town shall place in a special account all revenues received from the BRI Mill Levy imposed in the property within the District Boundaries under this Section VI and shall not expend such revenue until an agreement is executed between the District establishing the terms and conditions for the provision of the Regional Improvements; and (ii) if such an agreement is not executed within three (3) years from the date of the Approved Development Plan and neither Section B.1 nor B.2 above have occurred within three (3) years from the date of the Approved Development Plan, then the revenue from the BRI Mill Levy shall be conveyed to the Town for use by the Town in the planning, designing, constructing, installing, acquiring, relocating, redeveloping or financing of the Regional Improvements which benefit the service users or taxpayers of the District as prioritized and determined by the Town.

4. As set forth in the definition of the BRI Mill Levy, any District may, pursuant to written agreement with the Town, extend the terms for application of the BRI Mill Levy beyond the years set forth in the definition of the BRI Mill Levy.

5. The Districts each shall cease to be obligated to impose, collect and convey to the Town the revenue from the BRI Mill Levy described in this Section VI at such time as the area within the District's boundaries is included within a different district organized under the Special District Act, or a General Improvement District organized under Section 31-25-601, *et seq.*, C.R.S., or Business Improvement District organized under Section 31-25-1201, *et seq.*, C.R.S., which other district has been organized to fund a part or all of the Regional Improvements.

6. The Districts and Muegge Farms Metropolitan District Nos. 5, 6, 7, and 8 shall collectively have the authority to issue Debt for the Regional Improvements, in an aggregate amount among all the Districts and Muegge Farms Metropolitan District Nos. 5, 6, 7, and 8 not to exceed One-Hundred Eighty Million Dollars (\$180,000,000) pursuant to agreements as described in VI.A, B or C above. The Maximum Debt Mill Levy set forth below in Section VII.C below shall not include the BRI Mill Levy, but the Debt limit set forth in this Section VI, when added to the Debt limit for the Public Improvements set forth in Section VII.A. below, shall not exceed the Total Debt Limit. Any Debt issued by a District pursuant to this Section VI must be issued in compliance with and all requirements of State law, and shall comply with the debt parameters set forth in Section VII.D., below.

## **VII. FINANCIAL PROVISIONS**

### **A. General.**

The Districts shall be authorized to provide for the planning, design, acquisition, construction, installation, relocation and/or redevelopment of the Public Improvements from their revenues and by and through the proceeds of Debt to be issued by the Districts. A District may impose a mill levy on taxable property within its boundaries as a primary source of revenue for repayment of debt service and for operation and maintenance. A District may also rely upon various other revenue sources authorized by law. At a District's discretion, these may include the power to assess Fees as provided in Section 32-1-1001(l), C.R.S., as amended from time to time, and as limited by Section V.A.19 above, and a District may impose Special Assessments as provided in Section 32-1-1101.7, C.R.S., and in accordance with Section V.A.20 above.

The Financial Plan for the Districts and Muegge Farms Metropolitan District Nos. 5, 6, 7, and 8, which is attached hereto as **Exhibit D**, reflects that each District will issue no more Debt than that District can reasonably expect to pay from revenues derived from the Maximum Debt Mill Levy, Fees, Special Assessments and other legally available revenues. The aggregate amount of Debt the Districts and Muegge Farms Metropolitan District Nos. 5, 6, 7, and 8 shall be permitted to issue for the Public Improvements, except for the Regional Improvements, but including any Debt for Public Improvements to be constructed to serve any special improvement district, shall not exceed One-Hundred Eighty Million Dollars (\$180,000,000) and each District or Muegge Farms Metropolitan District Nos. 5, 6, 7, or 8 may issue such Debt on a schedule and in such year or years as the applicable District determines shall meet the needs of the Financial Plan referenced above and phased to serve development as it occurs. The Debt limit set forth in this Section VII.A., when added to the Debt limit for the Regional Public Improvements set forth in Section VI.B.4 above, shall not exceed the Total Debt Limit.

B. Maximum Voted Interest Rate and Maximum Underwriting Discount.

The interest rate on any Debt is expected to be the market rate at the time the Debt is issued and the proposed maximum interest rate on any Debt shall not exceed eighteen percent (18%). The proposed maximum underwriting discount will be five percent (5%). Debt, when issued, will comply with all relevant requirements of this Service Plan, State law and Federal law as then applicable to the issuance of public securities. As soon as practicable after a District Board has directed its staff or consultants to proceed with a Debt issuance, the District shall provide the Town written notice of its intention to issue Debt. No more than forty-five (45) days prior to issuing Debt nor less than thirty (30) days prior to issuing Debt, the District shall provide the proposed documents pursuant to which such Debt will be issued to the Town Administrator. The documents to be provided to the Town will include any of the following related to the Debt issuance: resolution of the District Board authorizing the issuance, indenture, if any, loan agreement, if any, or any other agreement creating or securing the Debt, any official statement or other document to be used to offer the Debt to investors, and the financing plan (collectively, the “**Proposed Debt Documents**”). If the Town determines that the issuance of the Debt on the terms set forth in the Proposed Debt Documents does not comply with this Service Plan or the provisions of any intergovernmental agreement between the District and the Town, the Town shall provide the issuing District with a written objection, and the bases therefor, within fifteen (15) days of the Town’s receipt of the Proposed Debt Documents. If the Town does not provide any written objection to the issuing District within fifteen (15) days of the Town’s receipt of the Proposed Debt Documents, the issuing District shall be entitled to proceed with the Debt issuance on the terms set forth in the Proposed Debt Documents without further notice to the Town. Failure to observe the requirements established in this paragraph shall constitute a material modification under the Service Plan and shall entitle the Town to all remedies available at law and in equity, including the remedies provided for in Section VII.D.4 below.

C. Mill Levies.

1. The Maximum Debt Mill Levy, which shall be subject to a Mill Levy Adjustment, shall be the maximum mill levy a District is permitted to impose upon the taxable property within the District for payment of Debt, and shall be fifty-five and two-hundred seventy-seven thousandths (55.277) mills for so long as the total amount of aggregate Debt of the District exceeds fifty percent (50%) of the District’s assessed valuation.

At such time as the total amount of aggregate Debt of a District is equal to or less than fifty percent (50%) of the District’s assessed valuation, either on the date of issuance of any Debt or at any time thereafter, the mill levy to be imposed to repay such portion of Debt shall not be subject to the Maximum Debt Mill Levy if End Users cast the majority of affirmative votes taken by the District’s Board of Directors at the meeting authorizing such action, and, as a result, the mill levy may be such amount as is necessary to pay the debt service on such Debt, and the Board may further provide that such Debt shall remain secured by such increased mill levy, notwithstanding any subsequent change in the District’s Debt to assessed value ratio.

2. The Maximum Operation and Maintenance Mill Levy, which shall be subject to a Mill Levy Adjustment, shall be the maximum mill levy a District is permitted to impose upon the taxable property within the District for payment of Operation and Maintenance



Costs, and shall be sixty-six and three-hundred thirty-three thousandths (66.333) mills until such time that the District issues Debt. After the District issues Debt, the Maximum Operation and Maintenance Mill Levy shall be eleven and fifty-six thousandths (11.056) mills. The Maximum Operation and Maintenance Mill Levy shall apply to the District's ability to increase its mill levy as necessary for provision of operation and maintenance services to its taxpayers and service users until such time as End Users cast the majority of affirmative votes taken by the District's Board of Directors at a meeting authorizing an increase of such Maximum Operation and Maintenance Mill Levy.

3. The Maximum Aggregate Mill Levy (which shall be adjusted to reflect any Mill Levy Adjustment in the Maximum Debt Mill Levy and the Maximum Operation and Maintenance Mill Levy) shall be the maximum combined mill levy a District is permitted to impose upon the taxable property within the District for payment of all expense categories, including, but not limited to, Debt, capital costs, organizational costs, and Operation and Maintenance Costs, and shall be sixty-six and three-hundred thirty-three thousandths (66.333) mills until such time as End Users cast the majority of affirmative votes taken by the District's Board of Directors at a meeting authorizing an increase of such Maximum Aggregate Mill Levy. The foregoing notwithstanding, any action taken by the District to increase the Maximum Debt Mill Levy must be taken in accordance with Section VII.C.1 above.

D. Debt Parameters.

1. All Debt issued by a District must be issued in compliance with the requirements of Section 32-1-1101, C.R.S., and all other requirements of State law. On or before the effective date of approval of an Approved Development Plan by the Town, no District shall: (a) issue any Debt; (b) impose a mill levy for the payment of Debt by direct imposition or by transfer of funds from the operating fund to the Debt service funds; (c) impose and collect any Fees used for the purpose of repayment of Debt, or (d) levy any Special Assessments.

2. No District shall pledge any revenue or property of the Town as security for the indebtedness set forth in this Service Plan. Approval of this Service Plan shall not be construed as a guarantee by the Town of payment of any of a District's obligations, nor shall anything in the Service Plan be construed so as to create any responsibility or liability on the part of the Town in the event of default by a District in the payment of any such obligation.

3. The Districts shall not issue Debt in excess of the Total Debt Limit, which amount is Three-Hundred Sixty Million Dollars (\$360,000,000), which Total Debt Limit includes any Debt issued for Public Improvements and Regional Improvements; provided that the foregoing shall not include the principal amount of Debt which has been refunded or which is a contractual pledge of taxes or other revenue from a District to another District.

4. Any Debt issued by a District with a pledge or which results in a pledge that exceeds the Maximum Debt Mill Levy (subject to the Mill Levy Adjustment) shall be deemed a material modification of this Service Plan pursuant to Section 32-1-207, C.R.S., and shall not be an authorized issuance of Debt unless and until such material modification has been approved by the Town as part of a Service Plan Amendment. The Town shall be entitled to all remedies available at law to enjoin such actions of the District, including the remedy of enjoining

the issuance of additional authorized but unissued debt, until such material modification is remedied.

E. Debt Instrument Disclosure Requirement.

In the text of each Bond and any other instrument representing and constituting Debt, a District shall set forth a statement in substantially the following form:

By acceptance of this instrument, the owner of this Bond agrees and consents to all of the limitations in respect of the payment of the principal of and interest on this Bond contained herein, in the resolution of the District authorizing the issuance of this Bond and in the Service Plan for creation of the District.

Similar language describing the limitations in respect of the payment of the principal of and interest on Debt set forth in this Service Plan shall be included in any document used for the offering of the Debt for sale to persons, including, but not limited to, a developer of property within the boundaries of a District.

F. Privately Placed Debt Limitation.

Prior to the issuance of any privately placed Debt, a District shall obtain the certification of an External Financial Advisor substantially as follows:

We are [I am] an External Financial Advisor within the meaning of the District's Service Plan.

We [I] certify that (1) the net effective interest rate (calculated as defined in Section 32-1-103(12), C.R.S.) to be borne by [insert the designation of the Debt] does not exceed a reasonable current [tax-exempt] [taxable] interest rate, using criteria deemed appropriate by us [me] and based upon our [my] analysis of comparable high yield securities; and (2) the structure of [insert designation of the Debt], including maturities and early redemption provisions, is reasonable considering the financial circumstances of the District.

G. TABOR Compliance.

The Districts will comply with the provisions of TABOR. In the discretion of the Board, a District may set up other qualifying entities to manage, fund, construct and operate facilities, services, and programs. To the extent allowed by law, any entity created by a District will remain under the control of that District's Board, and any such entity shall be subject to and bound by all terms, conditions, and limitations of the Service Plan and the Intergovernmental Agreement.

H. Districts' Organizational Costs and Operation and Maintenance Costs.

The Districts' Organizational Costs, including the estimated cost of acquiring land, engineering services, legal services and administrative services, together with the estimated costs of the Districts' organization and initial operations, are anticipated to be an aggregate amount of One Hundred Thousand Dollars (\$100,000), which will be eligible for reimbursement from Debt proceeds.

In addition to the capital costs of the Public Improvements, the Districts will require operating funds for Operation and Maintenance Costs, including administration, and to plan and cause the Public Improvements to be constructed and maintained, and for ongoing administrative, accounting and legal costs. The first year's operating budget for the Districts is estimated to be Fifty Thousand Dollars (\$50,000) which is anticipated to be derived from property taxes and other revenues.

**VIII. ANNUAL REPORT**

A. General.

Each District shall be responsible for submitting an annual report to the Town Clerk within six (6) months of the close of the fiscal year.

B. Reporting of Significant Events.

The annual report shall include information as to any of the following:

1. Boundary changes made or proposed to the District's boundary as of December 31 of the prior year.
2. Copies of the District's rules and regulations, if any, as of December 31 of the prior year.
3. A summary of any litigation which involves the Public Improvements as of December 31 of the prior year.
4. Status of the District's construction of the Public Improvements as of December 31 of the prior year.
5. A list of all facilities and improvements constructed by the District that have been dedicated to and accepted by the Town as of December 31 of the prior year.
6. Notice of any uncured events of default by the District, which continue beyond a ninety (90) day period, under any Debt instrument.
7. Any inability of the District to pay its obligations as they come due, in accordance with the terms of such obligations, which continue beyond a ninety (90) day period.

8. Any alteration or revision of the proposed schedule of Debt issuance set forth in the Financial Plan.

**IX. DISSOLUTION**

Upon an independent determination of the Town Board that the purposes for which a District was created have been accomplished, that District agrees to file petitions in the appropriate District Court for dissolution, pursuant to the applicable State statutes. In no event shall dissolution occur until the District has provided for the payment or discharge of all of its outstanding indebtedness and other financial obligations as required pursuant to State statutes.

**X. DISCLOSURE NOTICES**

Each District shall provide annual notice to all eligible electors of the District, in accordance with Section 32-1-809, C.R.S. In addition, each District shall annually record a District public disclosure document and a map of the District boundaries with the Clerk and Recorder of each County in which District property is located, in accordance with Section 32-1-104.8, C.R.S.

**XI. INTERGOVERNMENTAL AGREEMENT**

The form of the Intergovernmental Agreement required by the Town Code, relating to the limitations imposed on the Districts' activities, is attached hereto as **Exhibit G**. The Districts shall approve the Intergovernmental Agreement at their first Board meeting after its organizational election. Failure of the District to execute the Intergovernmental Agreement as required herein shall constitute a material modification and shall require a Service Plan Amendment. The Intergovernmental Agreement may be amended from time to time by the Districts and the Town, and may include written consents and agreements of the Town as required throughout this Service Plan. Alternatively, such written consents of the Town may be obtained by the Districts without amending the Intergovernmental Agreement, and the Town and each of the Districts may execute additional written agreements concerning matters set forth in this Service Plan.

**XII. CONCLUSION**

It is submitted that this Service Plan for the Districts, as required by Section 32-1-203(2), C.R.S., and Chapter 16, Article XX of the Town Code, establishes that:

1. There is sufficient existing and projected need for organized service in the area to be serviced by the Districts;
2. The existing service in the area to be served by the Districts is inadequate for present and projected needs;
3. The Districts are capable of providing economical and sufficient service to the area within its proposed boundaries; and

4. The area to be included in the Districts has, or will have, the financial ability to discharge the proposed indebtedness on a reasonable basis.

**EXHIBIT A**

**Vicinity Map**



**LEGEND**

 SITE



33220201 18-131 MUEGGE FARMS VICINITY MAP

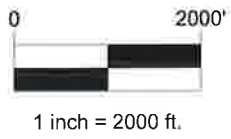

**MUEGGE FARMS  
VICINITY MAP**

CREATED BY: BAB      DATE: 02/12/2020

SHEET NUMBER  
**1**  
OF 1 SHEETS

JOB NUMBER  
18-131



**EXHIBIT B**

**INITIAL BOUNDARY MAP AND INCLUSION AREA BOUNDARY MAP**

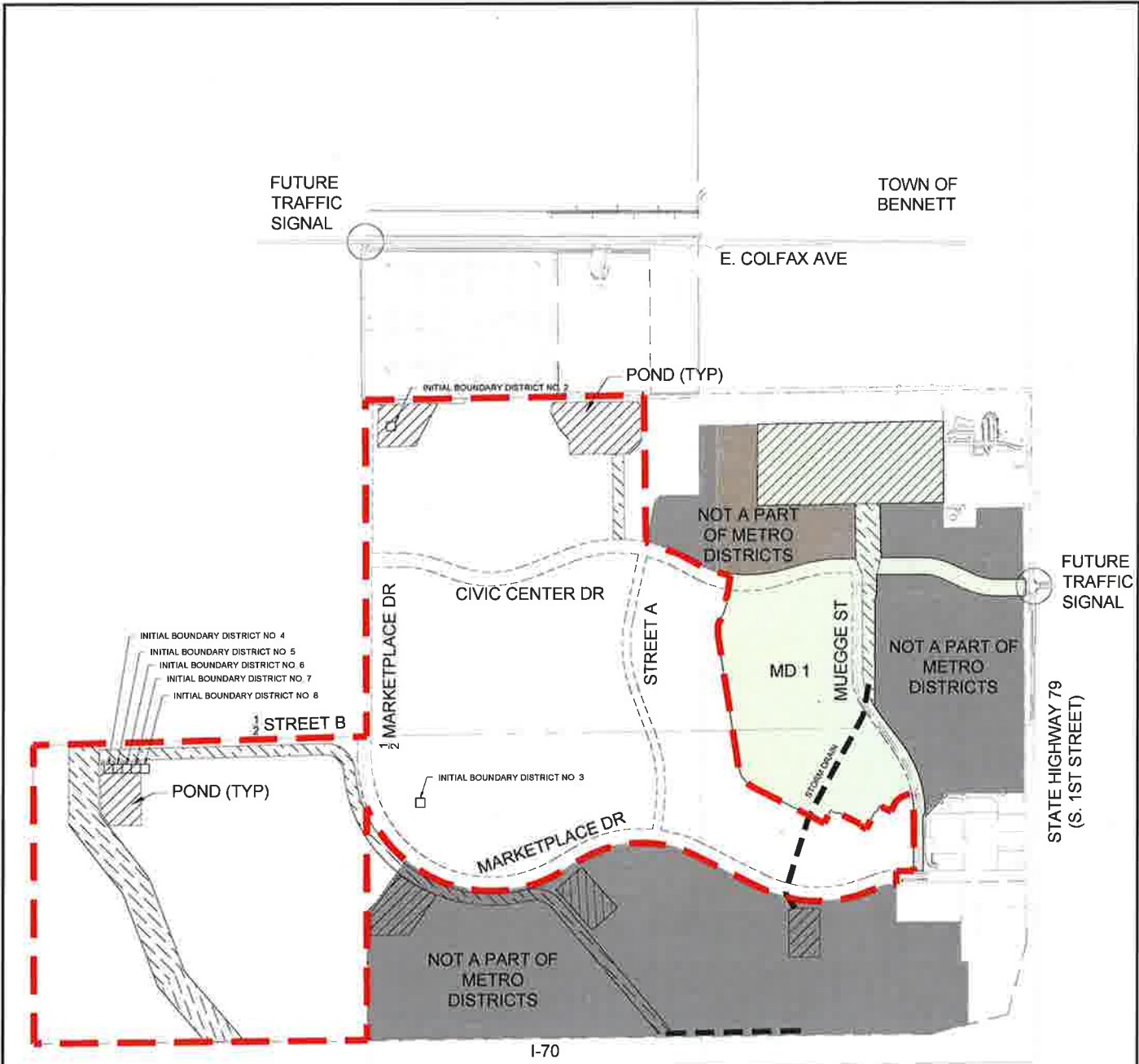



**LEGEND**

-  METRO BOUNDARY
-  INCLUSION AREA
-  METRO DISTRICT 1

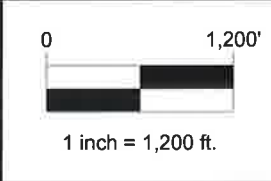

01/2020 11:56 AM X:\18-131\MUEGGEFARMS\BIB\18-131\MUEGGEFARMS-CITY\18-131\METRO DISTRICTS\STATE PLAN EXHIBIT.DWG

**MUEGGE FARMS**  
**SERVICE PLAN EXHIBIT**

CREATED BY: BAB      DATE: 01/31/2020

SHEET NUMBER  
**1**  
 OF 1 SHEETS

JOB NUMBER  
 18-131

**EXHIBIT C-1**

**LEGAL DESCRIPTION FOR DISTRICT NO. 1 INITIAL BOUNDARIES**

# EXHIBIT

## SECTION 33, TOWNSHIP 3 SOUTH, RANGE 63 WEST OF THE 6TH P.M., TOWN OF BENNETT, COUNTY OF ADAMS, STATE OF COLORADO

A PARCEL OF LAND LYING WITHIN THE EAST HALF OF SECTION 33, TOWNSHIP 3 SOUTH, RANGE 63 WEST OF THE SIXTH PRINCIPAL MERIDIAN, TOWN OF BENNETT, COUNTY OF ADAMS, STATE OF COLORADO, BEING MORE PARTICULARLY DESCRIBED AS FOLLOWS:

THE BEARINGS FOR THIS DESCRIPTION ARE BASED UPON THE SOUTH LINE OF THE NORTHEAST QUARTER OF SAID SECTION 33, BEING ASSUMED TO BEAR N 89°10'50" E, FROM THE CENTER QUARTER CORNER OF SAID SECTION 33, BEING MONUMENTED BY A REBAR WITH A 3-1/4 INCH ALUMINUM CAP STAMPED "PLS 25369 - 2017", TO THE EAST QUARTER CORNER OF SAID SECTION 33, BEING MONUMENTED BY A REBAR WITH A 3-1/4 INCH ALUMINUM CAP STAMPED "PLS 26715 - 2009", IN A RANGE BOX, WITH ALL BEARINGS CONTAINED HEREIN RELATIVE THERETO.

COMMENCING AT THE CENTER QUARTER CORNER OF SAID SECTION 33, THENCE S 51°36'54" E, A DISTANCE OF 374.58 FEET TO THE POINT OF BEGINNING.

THENCE N 08°50'00" W, A DISTANCE OF 1011.30 FEET;  
THENCE N 00°17'37" E, A DISTANCE OF 80.21 FEET;  
THENCE N 26°36'18" E, A DISTANCE OF 114.95 FEET;  
THENCE N 16°40'28" E, A DISTANCE OF 66.48 FEET;  
THENCE N 08°50'00" W, A DISTANCE OF 42.68 FEET;  
THENCE N 16°33'10" E, A DISTANCE OF 48.28 FEET;  
THENCE N 08°32'42" E, A DISTANCE OF 37.25 FEET;  
THENCE N 08°26'35" E, A DISTANCE OF 112.58 FEET TO A POINT OF NON-TANGENT CURVATURE;  
THENCE ALONG THE ARC OF A NON-TANGENT CURVE TO THE LEFT HAVING A RADIUS OF 945.00 FEET, A CENTRAL ANGLE OF 25°27'17" AND AN ARC LENGTH OF 419.83 FEET, THE CHORD OF WHICH BEARS N 85°59'22" E, A DISTANCE OF 416.39 FEET;  
THENCE N 73°15'43" E, A DISTANCE OF 148.93 FEET TO A POINT OF CURVATURE;  
THENCE ALONG THE ARC OF A CURVE TO THE RIGHT HAVING A RADIUS OF 1055.00 FEET, A CENTRAL ANGLE OF 16°44'17" AND AN ARC LENGTH OF 308.20 FEET;  
THENCE N 90°00'00" E, A DISTANCE OF 129.51 FEET;  
THENCE N 00°50'59" W, A DISTANCE OF 436.08 FEET;  
THENCE S 89°09'01" W, A DISTANCE OF 772.39 FEET;  
THENCE N 00°00'00" E, A DISTANCE OF 647.27 FEET TO A POINT ON THE SOUTH LINE OF THAT PARCEL OF LAND OWNED BY THE TOWN OF BENNETT RECORDED AT RECEPTION NO. 2012000072794, SAID ADAMS COUNTY RECORDS;  
THENCE N 89°09'01" E, ALONG SAID SOUTH LINE, A DISTANCE OF 1473.63 FEET TO A POINT ON THE WEST LINE OF THAT PARCEL OF LAND OWNED BY THE TOWN OF BENNETT RECORDED AT RECEPTION NO. C0495843, SAID ADAMS COUNTY RECORDS;  
THENCE S 00°23'33" E, ALONG SAID WEST LINE, A DISTANCE OF 647.38 FEET;  
THENCE S 89°10' 04" W, A DISTANCE OF 503.68 FEET;  
THENCE S 00°49'56" E, A DISTANCE OF 431.07 FEET;  
THENCE N 90°00'00" E, A DISTANCE OF 327.49 FEET TO A POINT OF CURVATURE;  
THENCE ALONG THE ARC OF A CURVE TO THE RIGHT HAVING A RADIUS OF 563.00 FEET, A CENTRAL ANGLE OF 25°00'00" AND AN ARC LENGTH OF 245.66 FEET;  
THENCE S 65°00'00" E, A DISTANCE OF 188.91 FEET TO A POINT OF CURVATURE;  
THENCE ALONG THE ARC OF A CURVE TO THE LEFT HAVING A RADIUS OF 435.00 FEET, A CENTRAL ANGLE OF 25°18'27" AND AN ARC LENGTH OF 192.14 FEET;  
THENCE N 89°41'33" E, A DISTANCE OF 229.62 FEET TO A POINT ON THE WEST LINE OF THE FIRST STREET/STATE HIGHWAY 79 RIGHT-OF-WAY;

NOTE: THIS DOES NOT REPRESENT A MONUMENTED SURVEY.  
IT IS INTENDED ONLY TO DEPICT THE ATTACHED DESCRIPTION

PROJECT: 18-131  
DATE: 02/20/2020  
SHEET 1 OF 6

DR: D. BUCHHOLZ  
DS: T. GIRARD  
P.M. D. FORBES



**CORE**  
CONSULTANTS

CIVIL ENGINEERING  
DEVELOPMENT CONSULTING  
NATURAL RESOURCES  
LAND SURVEYING  
303.703.4444  
1950 W. Littleton Blvd., Ste. 109  
Littleton, CO 80120

# EXHIBIT

## SECTION 33, TOWNSHIP 3 SOUTH, RANGE 63 WEST OF THE 6TH P.M., TOWN OF BENNETT, COUNTY OF ADAMS, STATE OF COLORADO

(CONTINUED)

THENCE S 00°24'47" E, ALONG SAID WEST LINE, A DISTANCE OF 133.00 FEET;  
THENCE S 89°41'33" W, A DISTANCE OF 236.43 FEET TO A POINT OF CURVATURE;  
THENCE ALONG THE ARC OF A CURVE TO THE RIGHT HAVING A RADIUS OF 570.00 FEET, A CENTRAL ANGLE OF 25°18'27" AND AN ARC LENGTH OF 251.77 FEET;  
THENCE N 65°00'00" W, A DISTANCE OF 188.55 FEET TO A POINT OF CURVATURE;  
THENCE ALONG THE ARC OF A CURVE TO THE LEFT HAVING A RADIUS OF 430.00 FEET, A CENTRAL ANGLE OF 25°00'00" AND AN ARC LENGTH OF 187.62 FEET;  
THENCE N 90°00'00" W, A DISTANCE OF 354.81 FEET;  
THENCE S 00°00'00" E, 148.68 FEET;  
THENCE S 12°25'16" W, A DISTANCE OF 56.15 FEET;  
THENCE S 00°00'00" E, A DISTANCE OF 824.09 FEET;  
THENCE S 61°53'54" W, A DISTANCE OF 15.00 FEET TO A POINT OF NON-TANGENT CURVATURE;  
THENCE ALONG THE ARC OF A NON-TANGENT CURVE TO THE LEFT HAVING A RADIUS OF 682.50 FEET, A CENTRAL ANGLE OF 09°22'25" AND AN ARC LENGTH OF 111.66 FEET, THE CHORD OF WHICH BEARS S 32°47'19" E, A DISTANCE OF 111.53 FEET;  
THENCE S 37°28'31" E, A DISTANCE OF 258.35 FEET TO A POINT OF CURVATURE;  
THENCE ALONG THE ARC OF A CURVE TO THE RIGHT HAVING A RADIUS OF 952.50 FEET, A CENTRAL ANGLE OF 37°16'01" AND AN ARC LENGTH OF 619.53 FEET TO A POINT ON THE NORTHWEST LINE OF MUEGGE FARMS FILING NO. 1 AMENDED, A SUBDIVISION PLAT RECORDED AT RECEPTION NO. 2007000007800 IN THE RECORDS OF THE ADAMS COUNTY CLERK AND RECORDER'S OFFICE;

THENCE ALONG THE NORTHWEST AND WEST LINES OF SAID MUEGGE FARMS FILING NO. 1 AMENDED, THE FOLLOWING TWO (2) COURSES:

1. S 44°45'00" W, A DISTANCE OF 21.21 FEET;
2. S 00°15'00" E, A DISTANCE OF 435.36 FEET TO THE SOUTHWEST CORNER OF SAID MUEGGE FARMS FILING NO. 1 AMENDED;

THENCE S 89°45'00" W, ALONG THE NORTH LINE OF MUEGGE FARMS FILING NO. 3, A SUBDIVISION PLAT RECORDED AT RECEPTION NO. 2014000011818, SAID ADAMS COUNTY RECORDS, A DISTANCE OF 75.00 FEET;  
THENCE N 00°15'00" W, A DISTANCE OF 451.05 FEET TO A POINT OF CURVATURE;  
THENCE ALONG THE ARC OF A CURVE TO THE LEFT HAVING A RADIUS OF 862.50 FEET, A CENTRAL ANGLE OF 11°10'15" AND AN ARC LENGTH OF 168.16 FEET;  
THENCE S 78°34'45" W, A DISTANCE OF 12.98 FEET;  
THENCE S 69°22'09" W, A DISTANCE OF 45.00 FEET;  
THENCE S 66°21'33" W, A DISTANCE OF 40.38 FEET;  
THENCE S 48°48'56" W, A DISTANCE OF 37.99 FEET;  
THENCE S 30°39'38" W, A DISTANCE OF 41.14 FEET;  
THENCE S 27°00'38" W, A DISTANCE OF 55.00 FEET;  
THENCE N 62°59'22" W, A DISTANCE OF 98.00 FEET;  
THENCE S 27°00'38" W, A DISTANCE OF 50.00 FEET;  
THENCE S 72°00'38" W, A DISTANCE OF 16.97 FEET;  
THENCE S 27°00'38" W, A DISTANCE OF 149.98 FEET;  
THENCE N 62°59'22" W, A DISTANCE OF 50.02 FEET;  
THENCE N 17°58'53" W, A DISTANCE OF 16.97 FEET;  
THENCE N 62°59'22" W, A DISTANCE OF 195.96 FEET;

NOTE: THIS DOES NOT REPRESENT A MONUMENTED SURVEY.  
IT IS INTENDED ONLY TO DEPICT THE ATTACHED DESCRIPTION

PROJECT: 18-131  
DATE: 02/20/2019  
SHEET 2 OF 6

DR: D. BUCHHOLZ  
DS: T. GIRARD  
P.M. D. FORBES



**CORE**  
CONSULTANTS

CIVIL ENGINEERING  
DEVELOPMENT CONSULTING  
NATURAL RESOURCES  
LAND SURVEYING  
303.703.4444  
1050 W. Littleton Blvd., Ste. 109  
Littleton, CO 80120

# EXHIBIT

SECTION 33, TOWNSHIP 3 SOUTH, RANGE 63 WEST OF THE 6TH P.M.,  
TOWN OF BENNETT, COUNTY OF ADAMS, STATE OF COLORADO

(CONTINUED)

THENCE S 72°00'41" W, A DISTANCE OF 17.00 FEET;  
THENCE N 62°59'28" W, A DISTANCE OF 50.00 FEET;  
THENCE S 27°00'38" W, A DISTANCE OF 110.98 FEET;  
THENCE N 62°59'22" W, A DISTANCE OF 642.39 FEET;  
THENCE N 56°54'09" W, A DISTANCE OF 42.42 FEET;  
THENCE N 40°31'03" W, A DISTANCE OF 71.51 FEET;  
THENCE N 19°57'27" W, A DISTANCE OF 71.26 FEET;  
THENCE N 08°51'07" W, A DISTANCE OF 68.92 FEET TO THE POINT OF BEGINNING.

CONTAINING AN AREA OF 3,666,143 SQUARE FEET, OR 84.163 ACRES MORE OR LESS.

THOMAS M. GIRARD  
COLORADO PLS 38151  
FOR AND ON BEHALF OF  
CORE CONSULTANTS, INC.



NOTE: THIS DOES NOT REPRESENT A MONUMENTED SURVEY.  
IT IS INTENDED ONLY TO DEPICT THE ATTACHED DESCRIPTION  
PROJECT: 18-131                      DR: D. BUCHHOLZ  
DATE: 02/20/2019                    DS: T. GIRARD  
SHEET 3 OF 6                         P.M. D. FORBES



**CORE**  
CONSULTANTS

CIVIL ENGINEERING  
DEVELOPMENT CONSULTING  
NATURAL RESOURCES  
LAND SURVEYING  
303.703.4444  
1950 W. Littleton Blvd., Ste. 109  
Littleton, CO 80120

# EXHIBIT

SECTION 33, TOWNSHIP 3 SOUTH, RANGE 63 WEST OF THE 6TH P.M.,  
TOWN OF BENNETT, COUNTY OF ADAMS, STATE OF COLORADO

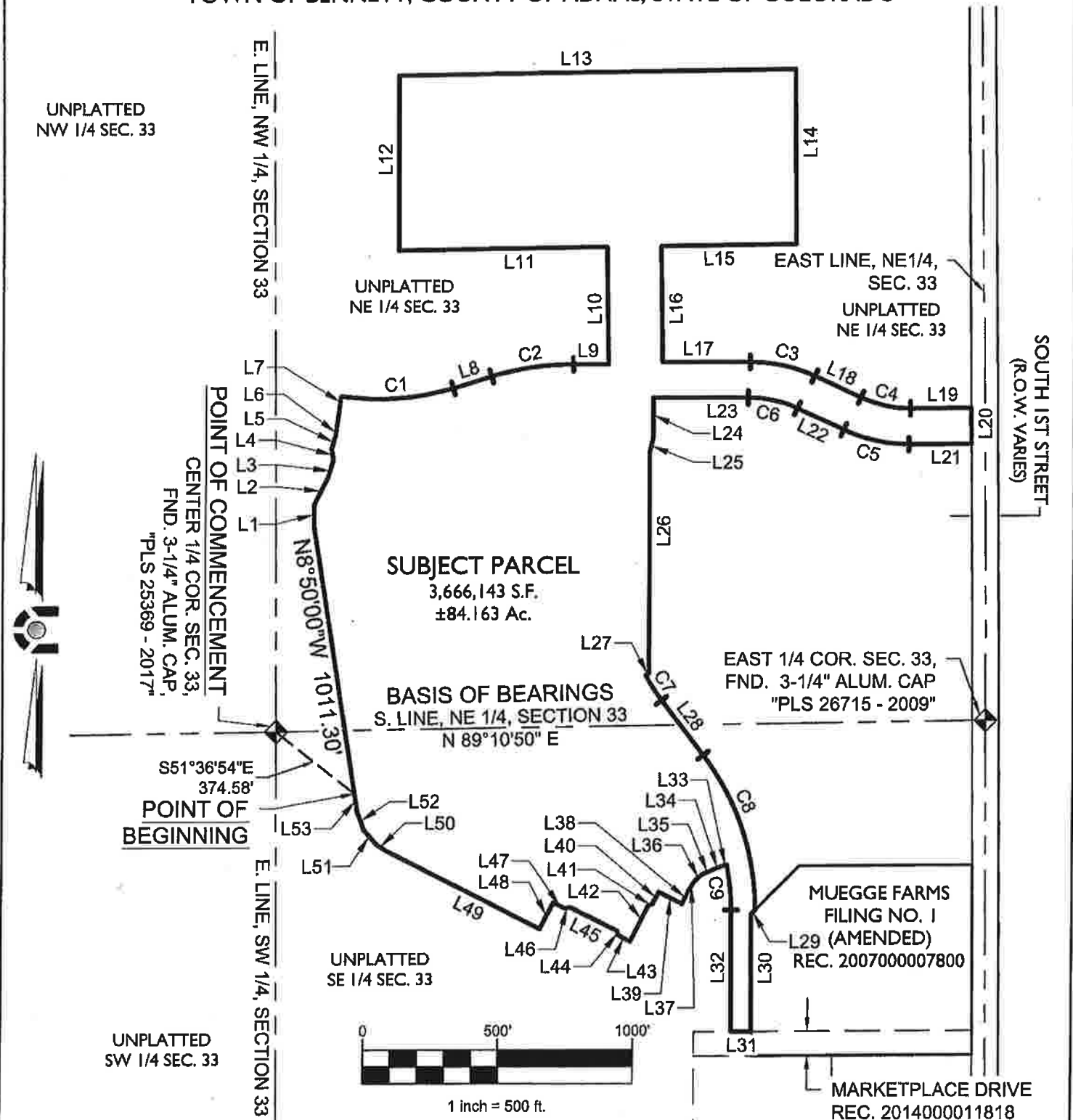

PARCEL CONTAINS 3,666,143 S.F. OR 84.163 Ac, MORE OR LESS.

NOTE: THIS DOES NOT REPRESENT A MONUMENTED SURVEY.  
IT IS INTENDED ONLY TO DEPICT THE ATTACHED DESCRIPTION

PROJECT: 18-131  
DATE: 02/20/2020  
SHEET 4 OF 6

DR: D. BUCHHOLZ  
DS: T. GIRARD  
P.M. D. FORBES



**CORE**  
CONSULTANTS

CIVIL ENGINEERING  
DEVELOPMENT CONSULTING  
NATURAL RESOURCES  
LAND SURVEYING  
303.703.4444  
1850 W. Littleton Blvd., Ste. 109  
Littleton, CO 80120

# EXHIBIT

SECTION 33, TOWNSHIP 3 SOUTH, RANGE 63 WEST OF THE 6TH P.M.,  
TOWN OF BENNETT, COUNTY OF ADAMS, STATE OF COLORADO

LINE TABLE		
LINE #	LENGTH	DIRECTION
L1	80.21'	N 0°17'37" E
L2	114.95'	N 26°36'18" E
L3	66.48'	N 16°40'28" E
L4	42.68'	N 8°50'00" W
L5	48.28'	N 16°33'10" E
L6	37.25'	N 8°32'42" E
L7	112.58'	N 8°26'35" E
L8	148.93'	N 73°15'43" E
L9	129.51'	N 90°00'00" E
L10	436.08'	N 0°50'59" W
L11	772.39'	S 89°09'01" W
L12	647.27'	N 0°00'00" E
L13	1473.63'	N 89°09'01" E
L14	647.38'	S 0°23'33" E
L15	503.68'	S 89°10'04" W
L16	431.07'	S 0°49'56" E
L17	327.49'	N 90°00'00" E
L18	188.91'	S 65°00'00" E
L19	229.62'	N 89°41'33" E
L20	133.00'	S 0°24'47" E
L21	236.43'	S 89°41'33" W
L22	188.55'	N 65°00'00" W
L23	354.81'	N 90°00'00" W

LINE TABLE		
LINE #	LENGTH	DIRECTION
L24	148.68'	S 0°00'00" E
L25	56.15'	S 12°25'16" W
L26	824.09'	S 0°00'00" E
L27	15.00'	S 61°53'54" W
L28	258.35'	S 37°28'31" E
L29	21.21'	S 44°45'00" W
L30	435.36'	S 0°15'00" E
L31	75.00'	S 89°45'00" W
L32	451.05'	N 0°15'00" W
L33	12.98'	S 78°34'45" W
L34	45.00'	S 69°22'09" W
L35	40.38'	S 66°21'33" W
L36	37.99'	S 48°48'56" W
L37	41.14'	S 30°39'38" W
L38	55.00'	S 27°00'38" W
L39	98.00'	N 62°59'22" W
L40	50.00'	S 27°00'38" W
L41	16.97'	S 72°00'38" W
L42	149.98'	S 27°00'38" W
L43	50.02'	N 62°59'22" W
L44	16.97'	N 17°58'53" W
L45	195.96'	N 62°59'22" W
L46	17.00'	S 72°00'41" W

NOTE: THIS DOES NOT REPRESENT A MONUMENTED SURVEY.  
IT IS INTENDED ONLY TO DEPICT THE ATTACHED DESCRIPTION

PROJECT: 18-131  
DATE: 02/20/2020  
SHEET 5 OF 6

DR: D. BUCHHOLZ  
DS: T. GIRARD  
P.M. D. FORBES



CORE

CONSULTANTS

CIVIL ENGINEERING  
DEVELOPMENT CONSULTING  
NATURAL RESOURCES  
LAND SURVEYING

303.703.4444  
1850 W. Littleton Blvd., Ste. 109  
Littleton, CO 80120

# EXHIBIT

SECTION 33, TOWNSHIP 3 SOUTH, RANGE 63 WEST OF THE 6TH P.M.,  
TOWN OF BENNETT, COUNTY OF ADAMS, STATE OF COLORADO

LINE TABLE		
LINE #	LENGTH	DIRECTION
L47	50.00'	N 62°59'28" W
L48	110.98'	S 27°00'38" W
L49	642.39'	N 62°59'22" W
L50	42.42'	N 56°54'09" W
L51	71.51'	N 40°31'03" W
L52	71.26'	N 19°57'27" W
L53	68.92'	N 8°51'07" W

CURVE TABLE					
CURVE #	LENGTH	RADIUS	DELTA	CHORD BEARING	CHORD LENGTH
C1	419.83'	945.00'	25°27'17"	N85°59'22"E	416.39'
C2	308.20'	1055.00'	16°44'17"	N81°37'52"E	307.10'
C3	245.66'	563.00'	25°00'00"	S77°30'00"E	243.71'
C4	192.14'	435.00'	25°18'27"	S77°39'13"E	190.58'
C5	251.77'	570.00'	25°18'27"	N77°39'13"W	249.73'
C6	187.62'	430.00'	25°00'00"	N77°30'00"W	186.14'
C7	111.66'	682.50'	9°22'25"	S32°47'19"E	111.53'
C8	619.53'	952.50'	37°16'01"	S18°50'31"E	608.67'
C9	168.16'	862.50'	11°10'15"	N5°50'08"W	167.89'

NOTE: THIS DOES NOT REPRESENT A MONUMENTED SURVEY.  
IT IS INTENDED ONLY TO DEPICT THE ATTACHED DESCRIPTION  
PROJECT: 18-131  
DATE: 02/20/2020  
SHEET 6 OF 6

DR: D. BUCHHOLZ  
DS: T. GIRARD  
P.M. D. FORBES



**CORE**  
CONSULTANTS

CIVIL ENGINEERING  
DEVELOPMENT CONSULTING  
NATURAL RESOURCES  
LAND SURVEYING  
303.703.4444  
1950 W. Littleton Blvd., Ste. 109  
Littleton, CO 80120



**EXHIBIT C-2**

**LEGAL DESCRIPTION FOR DISTRICT NO. 2 INITIAL BOUNDARIES**

# EXHIBIT

SOUTHWEST QUARTER, SECTION 33, TOWNSHIP 3 SOUTH, RANGE 63 WEST OF THE 6TH P.M.,  
TOWN OF BENNETT, COUNTY OF ADAMS, STATE OF COLORADO

## LEGAL DESCRIPTION:

A PARCEL OF LAND LYING WITHIN THE NORTHWEST QUARTER OF SECTION 33, TOWNSHIP 3 SOUTH,  
RANGE 63 WEST OF THE SIXTH PRINCIPAL MERIDIAN, TOWN OF BENNETT, COUNTY OF ADAMS, STATE  
OF COLORADO, BEING MORE PARTICULARLY DESCRIBED AS FOLLOWS:

THE BEARINGS FOR THIS DESCRIPTION ARE BASED UPON THE WEST LINE OF THE SOUTHWEST  
QUARTER OF SAID SECTION 33, BEING ASSUMED TO BEAR S 00°15'50" E, FROM THE NORTHWEST  
CORNER OF SAID SECTION 33, BEING MONUMENTED BY AN ALUMINUM ROD WITH A 3-1/4 INCH  
ALUMINUM CAP STAMPED "PLS 30086 - 1998", TO THE WEST QUARTER CORNER OF SAID  
SECTION 33, BEING MONUMENTED BY A REBAR WITH A 3-1/4 INCH ALUMINUM CAP  
STAMPED "PLS 24942 - 2004", WITH ALL BEARINGS CONTAINED HEREIN RELATIVE THERETO.

COMMENCING AT THE WEST QUARTER CORNER OF SAID SECTION 33, THENCE S 42°51'37" E, A  
DISTANCE OF 242.03 FEET TO THE POINT OF BEGINNING.

THENCE N 90°00'00" E, A DISTANCE OF 71.00 FEET;  
THENCE S 00°00'00" E, A DISTANCE OF 71.00 FEET;  
THENCE S 90°00'00" W, A DISTANCE OF 71.00 FEET;  
THENCE N 00°00'00" W, A DISTANCE OF 71.00 FEET TO THE POINT OF BEGINNING.

CONTAINING AN AREA OF 5,041 SQUARE FEET OR 0.116 ACRES, MORE OR LESS.

THOMAS M. GIRARD  
COLORADO PLS 38151  
FOR AND ON BEHALF OF  
CORE CONSULTANTS, INC.



NOTE: THIS DOES NOT REPRESENT A MONUMENTED SURVEY.  
IT IS INTENDED ONLY TO DEPICT THE ATTACHED DESCRIPTION

PROJECT: 18-131  
DATE: 02/24/2020  
SHEET 1 OF 2

DR: K. SIBLEY  
DS: T. GIRARD  
P.M. D. FORBES



**CORE**  
CONSULTANTS

CIVIL ENGINEERING  
DEVELOPMENT CONSULTING  
NATURAL RESOURCES  
LAND SURVEYING  
303.703.4444  
1950 W. Littleton Blvd., Ste. 109  
Littleton, CO 80120

# EXHIBIT

SOUTHWEST QUARTER, SECTION 33, TOWNSHIP 3 SOUTH, RANGE 63 WEST OF THE 6TH P.M.,  
TOWN OF BENNETT, COUNTY OF ADAMS, STATE OF COLORADO

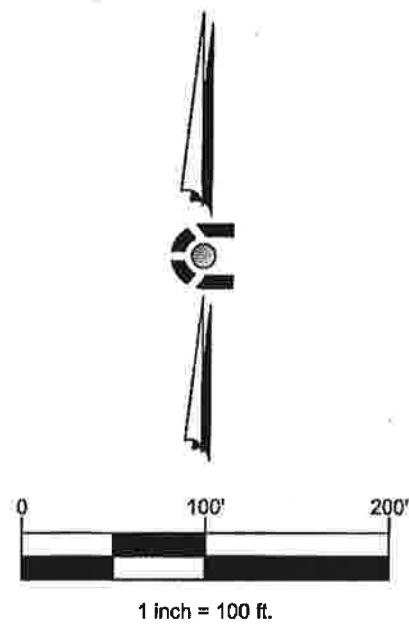
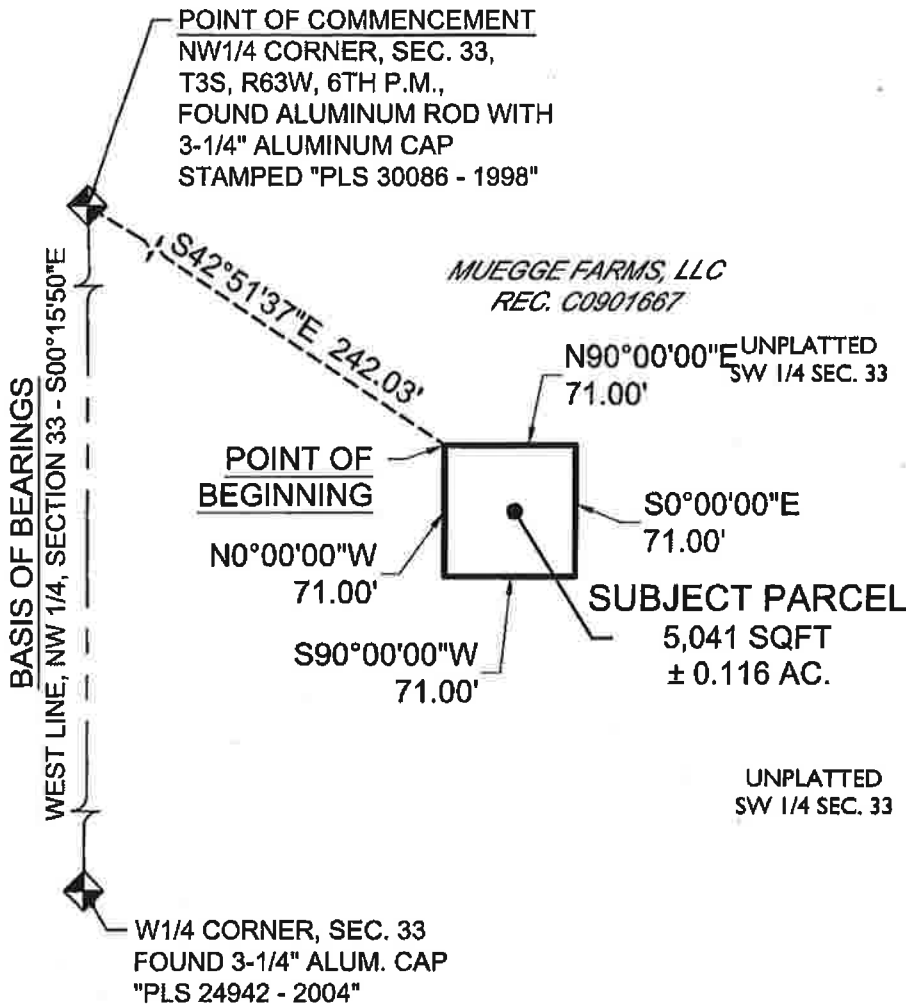

PARCEL CONTAINS 5,041 S.F. OR 0.116 Ac, MORE OR LESS.  
NOTE: THIS DOES NOT REPRESENT A MONUMENTED SURVEY.  
IT IS INTENDED ONLY TO DEPICT THE ATTACHED DESCRIPTION

PROJECT: 18-131  
DATE: 02/24/2020  
SHEET 2 OF 2

DR: K. SIBLEY  
DS: T. GIRARD  
P.M. D. FORBES

**CORE**  
CONSULTANTS

CIVIL ENGINEERING  
DEVELOPMENT CONSULTING  
NATURAL RESOURCES  
LAND SURVEYING

303.703.4444  
1950 W. Littleton Blvd., Ste. 109  
Littleton, CO 80120

**EXHIBIT C-3**

**LEGAL DESCRIPTION FOR DISTRICT NO. 3 INITIAL BOUNDARIES**

# EXHIBIT

SOUTHWEST QUARTER, SECTION 33, TOWNSHIP 3 SOUTH, RANGE 63 WEST OF THE 6TH P.M.,  
TOWN OF BENNETT, COUNTY OF ADAMS, STATE OF COLORADO

## LEGAL DESCRIPTION:

A PARCEL OF LAND LYING WITHIN THE SOUTHWEST QUARTER OF SECTION 33, TOWNSHIP 3 SOUTH,  
RANGE 63 WEST OF THE SIXTH PRINCIPAL MERIDIAN, TOWN OF BENNETT, COUNTY OF ADAMS, STATE  
OF COLORADO, BEING MORE PARTICULARLY DESCRIBED AS FOLLOWS:

THE BEARINGS FOR THIS DESCRIPTION ARE BASED UPON THE WEST LINE OF THE SOUTHWEST  
QUARTER OF SAID SECTION 33, BEING ASSUMED TO BEAR S 00°15'46" E, FROM THE WEST QUARTER  
CORNER OF SAID SECTION 33, BEING MONUMENTED BY A REBAR WITH A 3-1/4 INCH ALUMINUM CAP  
STAMPED "PLS 24942 - 2004", TO THE SOUTHWEST CORNER OF SAID SECTION 33, BEING MONUMENTED  
BY A REBAR WITH A 3-1/4 INCH ALUMINUM CAP STAMPED "PLS 25369 - 2017", WITH ALL BEARINGS  
CONTAINED HEREIN RELATIVE THERETO.

COMMENCING AT THE WEST QUARTER CORNER OF SAID SECTION 33, THENCE S 38°17'18" E, A  
DISTANCE OF 632.95 FEET TO THE POINT OF BEGINNING.

THENCE N 90°00'00" E, A DISTANCE OF 71.00 FEET;  
THENCE S 00°00'00" E, A DISTANCE OF 71.00 FEET;  
THENCE S 90°00'00" W, A DISTANCE OF 71.00 FEET;  
THENCE N 00°00'00" W, A DISTANCE OF 71.00 FEET TO THE POINT OF BEGINNING.

CONTAINING AN AREA OF 5,041 SQUARE FEET OR 0.116 ACRES, MORE OR LESS.

THOMAS M. GIRARD  
COLORADO PLS 38151  
FOR AND ON BEHALF OF  
CORE CONSULTANTS, INC.



NOTE: THIS DOES NOT REPRESENT A MONUMENTED SURVEY.  
IT IS INTENDED ONLY TO DEPICT THE ATTACHED DESCRIPTION

PROJECT: 18-131  
DATE: 02/24/2020  
SHEET 1 OF 2

DR: K. SIBLEY  
DS: T. GIRARD  
P.M. D. FORBES



**CORE**  
CONSULTANTS

CIVIL ENGINEERING  
DEVELOPMENT CONSULTING  
NATURAL RESOURCES  
LAND SURVEYING  
303.703.4444  
1950 W. Littleton Blvd., Ste. 109  
Littleton, CO 80120

# EXHIBIT

SOUTHWEST QUARTER, SECTION 33, TOWNSHIP 3 SOUTH, RANGE 63 WEST OF THE 6TH P.M.,  
TOWN OF BENNETT, COUNTY OF ADAMS, STATE OF COLORADO

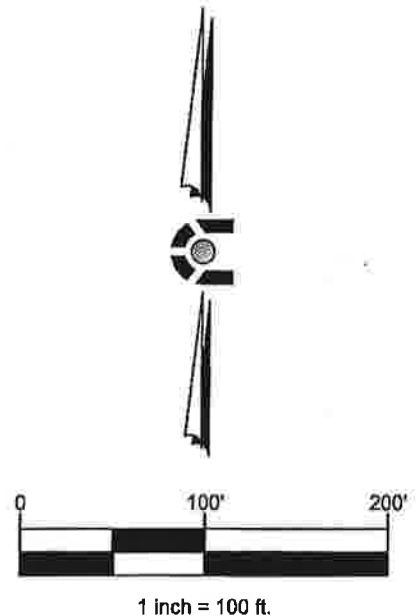
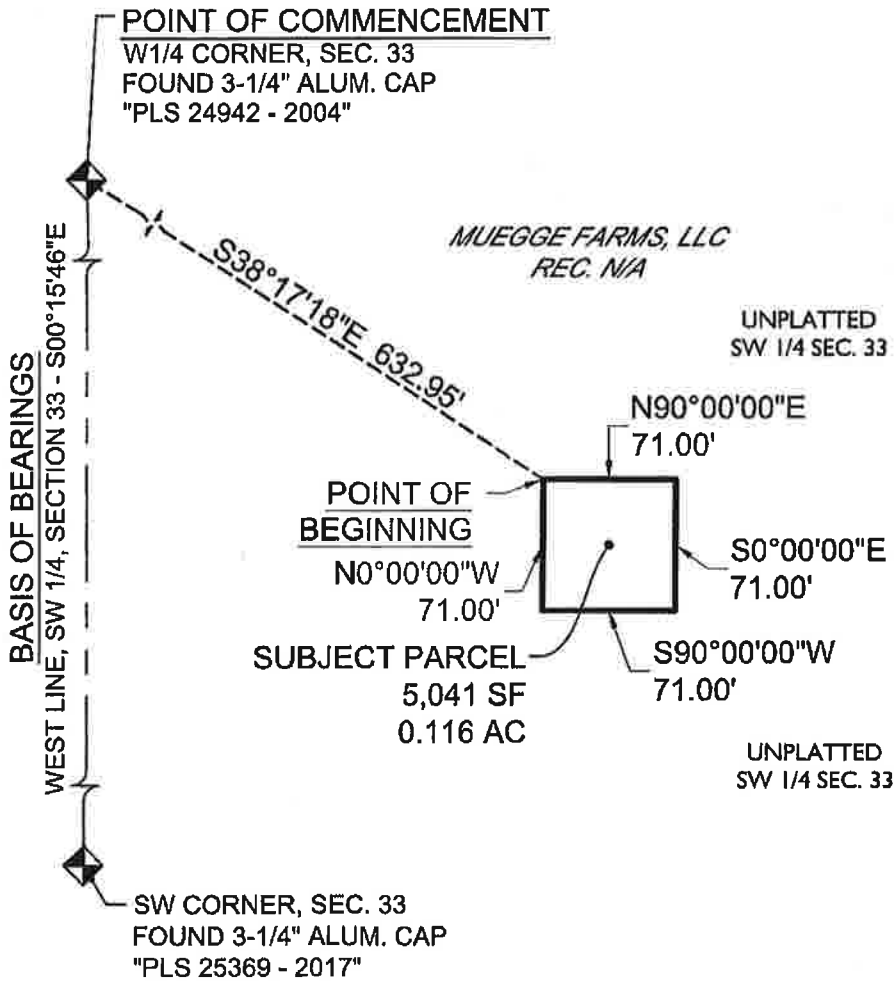

PARCEL CONTAINS 5,041 S.F. OR 0.116 Ac, MORE OR LESS.  
NOTE: THIS DOES NOT REPRESENT A MONUMENTED SURVEY.  
IT IS INTENDED ONLY TO DEPICT THE ATTACHED DESCRIPTION

PROJECT: 18-131  
DATE: 02/24/2020  
SHEET 2 OF 2

DR: K. SIBLEY  
DS: T. GIRARD  
P.M. D. FORBES



**CORE**  
CONSULTANTS

CIVIL ENGINEERING  
DEVELOPMENT CONSULTING  
NATURAL RESOURCES  
LAND SURVEYING

303.703.4444  
1950 W. Littleton Blvd., Ste. 109  
Littleton, CO 80120

**EXHIBIT C-4**

**LEGAL DESCRIPTION FOR DISTRICT NO. 4 INITIAL BOUNDARIES**

# EXHIBIT

SOUTHEAST QUARTER, SECTION 32, TOWNSHIP 3 SOUTH, RANGE 63 WEST OF THE 6TH P.M.,  
TOWN OF BENNETT, COUNTY OF ADAMS, STATE OF COLORADO

## LEGAL DESCRIPTION:

A PARCEL OF LAND LYING WITHIN THE SOUTHEAST QUARTER OF SECTION 32, TOWNSHIP 3 SOUTH,  
RANGE 63 WEST OF THE SIXTH PRINCIPAL MERIDIAN, TOWN OF BENNETT, COUNTY OF ADAMS, STATE  
OF COLORADO, BEING MORE PARTICULARLY DESCRIBED AS FOLLOWS:

THE BEARINGS FOR THIS DESCRIPTION ARE BASED UPON THE EAST LINE OF THE SOUTHEAST QUARTER  
OF SAID SECTION 32, BEING ASSUMED TO BEAR N 00° 15' 46" W, FROM THE EAST QUARTER CORNER OF  
SAID SECTION 32, BEING MONUMENTED BY A REBAR WITH A 3-1/4 INCH ALUMINUM CAP  
STAMPED "PLS 24942 - 2004", TO THE SOUTHEAST CORNER OF SAID SECTION 32, BEING MONUMENTED  
BY A REBAR WITH A 3-1/4 INCH ALUMINUM CAP STAMPED "PLS 25369 - 2017", WITH ALL BEARINGS  
CONTAINED HEREIN RELATIVE THERETO.

COMMENCING AT THE EAST QUARTER CORNER OF SAID SECTION 32, THENCE S 83° 45' 19" W, A  
DISTANCE OF 2018.99 FEET TO THE POINT OF BEGINNING.

THENCE S 00° 00' 00" W, A DISTANCE OF 71.00 FEET;  
THENCE N 90° 00' 00" W, A DISTANCE OF 71.00 FEET;  
THENCE N 00° 00' 00" E, A DISTANCE OF 71.00 FEET;  
THENCE N 90° 00' 00" E, A DISTANCE OF 71.00 FEET TO THE POINT OF BEGINNING.

CONTAINING AN AREA OF 5,041 SQUARE FEET OR 0.116 ACRES, MORE OR LESS.

THOMAS M. GIRARD  
COLORADO PLS 38151  
FOR AND ON BEHALF OF  
CORE CONSULTANTS, INC.



NOTE: THIS DOES NOT REPRESENT A MONUMENTED SURVEY.  
IT IS INTENDED ONLY TO DEPICT THE ATTACHED DESCRIPTION  
PROJECT: 18-131 DR: K. SIBLEY  
DATE: 02/24/2020 DS: T. GIRARD  
SHEET 1 OF 2 P.M. D. FORBES



**CORE**  
CONSULTANTS

CIVIL ENGINEERING  
DEVELOPMENT CONSULTING  
NATURAL RESOURCES  
LAND SURVEYING  
303.708.4444  
1950 W. Littleton Blvd., Ste. 109  
Littleton, CO 80120



# EXHIBIT

SOUTHEAST QUARTER, SECTION 32, TOWNSHIP 3 SOUTH, RANGE 63 WEST OF THE 6TH P.M.,  
TOWN OF BENNETT, COUNTY OF ADAMS, STATE OF COLORADO

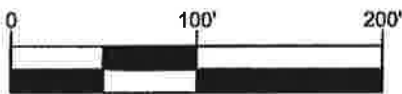
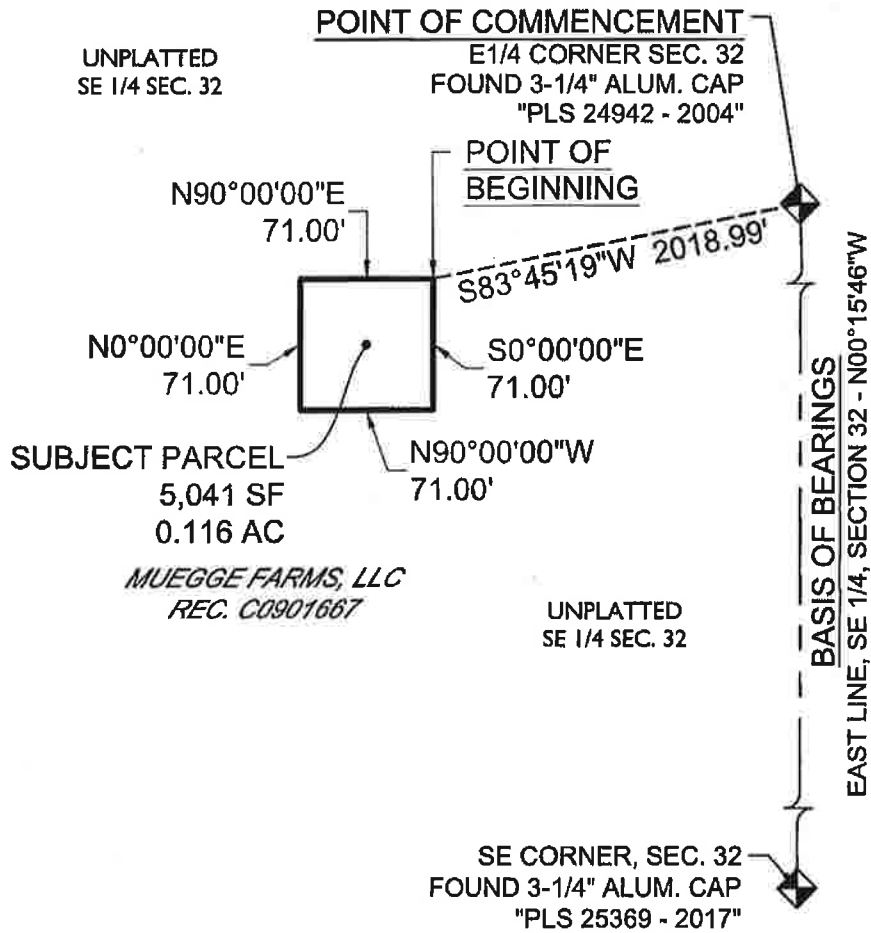

1 Inch = 100 ft.

PARCEL CONTAINS 5,041 S.F. OR 0.116 Ac, MORE OR LESS.

NOTE: THIS DOES NOT REPRESENT A MONUMENTED SURVEY.  
IT IS INTENDED ONLY TO DEPICT THE ATTACHED DESCRIPTION

PROJECT: 18-131

DATE: 02/24/2020

SHEET 2 OF 2

DR: K. SIBLEY

DS: T. GIRARD

P.M. D. FORBES



**CORE**  
CONSULTANTS

CIVIL ENGINEERING  
DEVELOPMENT CONSULTING  
NATURAL RESOURCES  
LAND SURVEYING  
303.703.4444  
1950 W. Littleton Blvd, Ste. 109  
Littleton, CO 80120

**EXHIBIT C-5**

**Legal Description for Inclusion Area**

# EXHIBIT

## SECTIONS 32 AND 33, TOWNSHIP 3 SOUTH, RANGE 63 WEST OF THE 6TH P.M., TOWN OF BENNETT, COUNTY OF ADAMS, STATE OF COLORADO

### LEGAL DESCRIPTION:

A PARCEL OF LAND LYING WITHIN SECTIONS 32 AND 33, TOWNSHIP 3 SOUTH, RANGE 63 WEST OF THE SIXTH PRINCIPAL MERIDIAN, TOWN OF BENNETT, COUNTY OF ADAMS, STATE OF COLORADO, BEING MORE PARTICULARLY DESCRIBED AS FOLLOWS:

THE BEARINGS FOR THIS DESCRIPTION ARE BASED UPON THE WEST LINE OF THE NORTHWEST QUARTER OF SAID SECTION 33, BEING ASSUMED TO BEAR N 00° 15' 50" W, FROM THE WEST QUARTER CORNER OF SAID SECTION 33, BEING MONUMENTED BY A REBAR WITH A 3-1/4 INCH ALUMINUM CAP STAMPED "PLS 24942 - 2004", TO THE NORTHWEST CORNER OF SAID SECTION 33, BEING MONUMENTED BY AN ALUMINUM ROD WITH A 3-1/4 INCH ALUMINUM CAP STAMPED "PLS 30086 - 2004", WITH ALL BEARINGS CONTAINED HEREIN RELATIVE THERETO.

BEGINNING AT THE WEST QUARTER CORNER OF SAID SECTION 33, THENCE N 00° 15' 50" W, A DISTANCE OF 2677.59 FEET TO THE NORTHWEST CORNER OF SAID SECTION 33;  
THENCE N 89° 09' 04" E, ALONG THE NORTH LINE OF THE NORTHWEST QUARTER OF SAID SECTION 33, A DISTANCE OF 2198.29 FEET;  
THENCE S 00° 50' 56" E, A DISTANCE OF 1169.22 FEET TO A POINT OF NON-TANGENT CURVATURE;  
THENCE ALONG THE ARC OF A NON-TANGENT CURVE TO THE RIGHT HAVING A RADIUS OF 1055.00 FEET, A CENTRAL ANGLE OF 13° 45' 55" AND AN ARC LENGTH OF 290.29 FEET, THE CHORD OF WHICH BEARS S 69° 52' 50" E A DISTANCE OF 289.38 FEET;  
THENCE S 61° 59' 52" E, A DISTANCE OF 218.24 FEET TO A POINT OF CURVATURE;  
THENCE ALONG THE ARC OF A CURVE TO THE LEFT HAVING A RADIUS OF 695.00 FEET, A CENTRAL ANGLE OF 18° 05' 38" AND AN ARC LENGTH OF 219.48 FEET;  
THENCE S 08° 26' 35" W, A DISTANCE OF 92.78 FEET;  
THENCE S 08° 32' 42" W, A DISTANCE OF 37.25 FEET;  
THENCE S 16° 33' 10" W, A DISTANCE OF 48.28 FEET;  
THENCE S 08° 50' 00" E, A DISTANCE OF 42.68 FEET;  
THENCE S 16° 40' 28" W, A DISTANCE OF 66.48 FEET;  
THENCE S 26° 36' 18" W, A DISTANCE OF 114.95 FEET;  
THENCE S 00° 17' 37" W, A DISTANCE OF 80.21 FEET;  
THENCE S 08° 50' 00" E, A DISTANCE OF 1011.30 FEET;  
THENCE S 08° 51' 07" E, A DISTANCE OF 68.92 FEET;  
THENCE S 19° 57' 27" E, A DISTANCE OF 71.26 FEET;  
THENCE S 40° 31' 03" E, A DISTANCE OF 71.51 FEET;  
THENCE S 56° 54' 09" E, A DISTANCE OF 42.42 FEET;  
THENCE S 62° 59' 22" E, A DISTANCE OF 642.39 FEET;  
THENCE N 27° 00' 38" E, A DISTANCE OF 110.98 FEET;  
THENCE S 62° 59' 28" E, A DISTANCE OF 50.00 FEET;  
THENCE N 72° 00' 41" E, A DISTANCE OF 17.00 FEET;  
THENCE S 62° 59' 22" E, A DISTANCE OF 195.96 FEET;  
THENCE S 17° 58' 53" E, A DISTANCE OF 16.97 FEET;  
THENCE S 62° 59' 22" E, A DISTANCE OF 50.02 FEET;  
THENCE N 27° 00' 38" E, A DISTANCE OF 149.98 FEET;  
THENCE N 72° 00' 38" E, A DISTANCE OF 16.97 FEET;  
THENCE N 27° 00' 38" E, A DISTANCE OF 50.00 FEET;  
THENCE S 62° 59' 22" E, A DISTANCE OF 98.00 FEET;  
THENCE N 27° 00' 38" E, A DISTANCE OF 55.00 FEET;  
THENCE N 30° 39' 38" E, A DISTANCE OF 41.14 FEET;  
THENCE N 48° 48' 56" E, A DISTANCE OF 37.99 FEET;  
THENCE N 66° 21' 33" E, A DISTANCE OF 40.38 FEET;  
THENCE N 69° 22' 09" E, A DISTANCE OF 45.00 FEET;

NOTE: THIS DOES NOT REPRESENT A MONUMENTED SURVEY.  
IT IS INTENDED ONLY TO DEPICT THE ATTACHED DESCRIPTION

PROJECT: 18-131  
DATE: 02/24/2020  
SHEET 1 OF 5

DR: K. SIBLEY  
DS: T. GIRARD  
P.M. D. FORBES



**CORE**  
CONSULTANTS

CIVIL ENGINEERING  
DEVELOPMENT CONSULTING  
NATURAL RESOURCES  
LAND SURVEYING  
303.703.4444  
1950 W. Littleton Blvd., Ste. 109  
Littleton, CO 80120

# EXHIBIT

## SECTIONS 32 AND 33, TOWNSHIP 3 SOUTH, RANGE 63 WEST OF THE 6TH P.M., TOWN OF BENNETT, COUNTY OF ADAMS, STATE OF COLORADO

(CONTINUED)

THENCE N 78°34'45" E, A DISTANCE OF 12.98 FEET TO A POINT OF NON-TANGENT CURVATURE;  
THENCE ALONG THE ARC OF A NON-TANGENT CURVE TO THE RIGHT HAVING A RADIUS OF 862.50 FEET, A  
CENTRAL ANGLE OF 11°10'15" AND AN ARC LENGTH OF 168.16 FEET, THE CHORD OF WHICH BEARS S 05°50'08" E, A  
DISTANCE OF 167.89;  
THENCE S 00°15'00" E, A DISTANCE OF 451.05 FEET TO A POINT ON THE NORTH LINE OF MUEGGE FARMS FILING  
NO. 3, A SUBDIVISION PLAT RECORDED AT RECEPTION NO. 2014000011818 IN THE RECORDS OF THE ADAMS  
COUNTY CLERK AND RECORDER'S OFFICE;  
THENCE S 89°45'00" W, ALONG SAID NORTH LINE, A DISTANCE OF 139.44 FEET TO THE NORTHWEST CORNER OF  
SAID MUEGGE FARMS FILING NO. 3;  
THENCE S 00°15'00" E, ALONG THE WEST LINE OF SAID MUEGGE FARMS FILING NO. 3, A DISTANCE OF 90.00 FEET;  
THENCE S 89°45'00" W, A DISTANCE OF 3.26 FEET TO A POINT OF CURVATURE;  
THENCE ALONG THE ARC OF A CURVE TO THE LEFT HAVING A RADIUS OF 200.00 FEET, A CENTRAL ANGLE OF  
21°39'36" AND AN ARC LENGTH OF 75.61 FEET;  
THENCE S 68°05'24" W, A DISTANCE OF 161.00 FEET TO A POINT OF CURVATURE;  
THENCE ALONG THE ARC OF A CURVE TO THE RIGHT HAVING A RADIUS OF 1055.00 FEET, A CENTRAL ANGLE OF  
48°55'13" AND AN ARC LENGTH OF 900.78 FEET;  
THENCE N 62°59'22" W, A DISTANCE OF 555.60 FEET TO A POINT OF CURVATURE;  
THENCE ALONG THE ARC OF A CURVE TO THE LEFT HAVING A RADIUS OF 945.00 FEET, A CENTRAL ANGLE OF  
58°39'23" AND AN ARC LENGTH OF 967.44 FEET;  
THENCE S 58°21'15" W, A DISTANCE OF 163.27 FEET TO A POINT OF CURVATURE;  
THENCE ALONG THE ARC OF A CURVE TO THE RIGHT HAVING A RADIUS OF 1055.00 FEET, A CENTRAL ANGLE OF  
100°23'34" AND AN ARC LENGTH OF 1848.55 FEET TO A POINT ON THE WEST LINE OF THE SOUTHWEST QUARTER  
OF SAID SECTION 33;  
THENCE S 00°15'46" E, ALONG SAID WEST LINE, A DISTANCE OF 1857.53 FEET;  
THENCE S 89°29'38" W, A DISTANCE OF 2642.09 FEET TO A POINT ON THE WEST LINE OF THE SOUTHEAST  
QUARTER OF SAID SECTION 32;  
THENCE N 00°13'40" W, ALONG THE WEST LINE OF THE SOUTHEAST QUARTER OF SAID SECTION 32, A DISTANCE  
OF 2376.10 FEET TO THE CENTER QUARTER CORNER OF SAID SECTION 33;  
THENCE N 88°32'43" E, ALONG THE NORTH LINE OF THE SOUTHEAST QUARTER OF SAID SECTION 33, A DISTANCE  
2641.19 FEET TO THE POINT OF BEGINNING.

THOMAS M. GIRARD  
COLORADO PLS 38151  
FOR AND ON BEHALF OF  
CORE CONSULTANTS, INC.  
1950 S. LITTLETON BLVD, SUITE 109  
LITTLETON, CO. 80120



NOTE: THIS DOES NOT REPRESENT A MONUMENTED SURVEY.  
IT IS INTENDED ONLY TO DEPICT THE ATTACHED DESCRIPTION

PROJECT: 18-131  
DATE: 02/24/2020  
SHEET 2 OF 5

DR: K. SIBLEY  
DS: T. GIRARD  
P.M. D. FORBES



**CORE**  
CONSULTANTS

CIVIL ENGINEERING  
DEVELOPMENT CONSULTING  
NATURAL RESOURCES  
LAND SURVEYING  
303.703.4444  
1950 W. Littleton Blvd., Ste. 109  
Littleton, CO 80120

# EXHIBIT

SECTIONS 32 AND 33, TOWNSHIP 3 SOUTH, RANGE 63 WEST OF THE 6TH P.M.,  
TOWN OF BENNETT, COUNTY OF ADAMS, STATE OF COLORADO

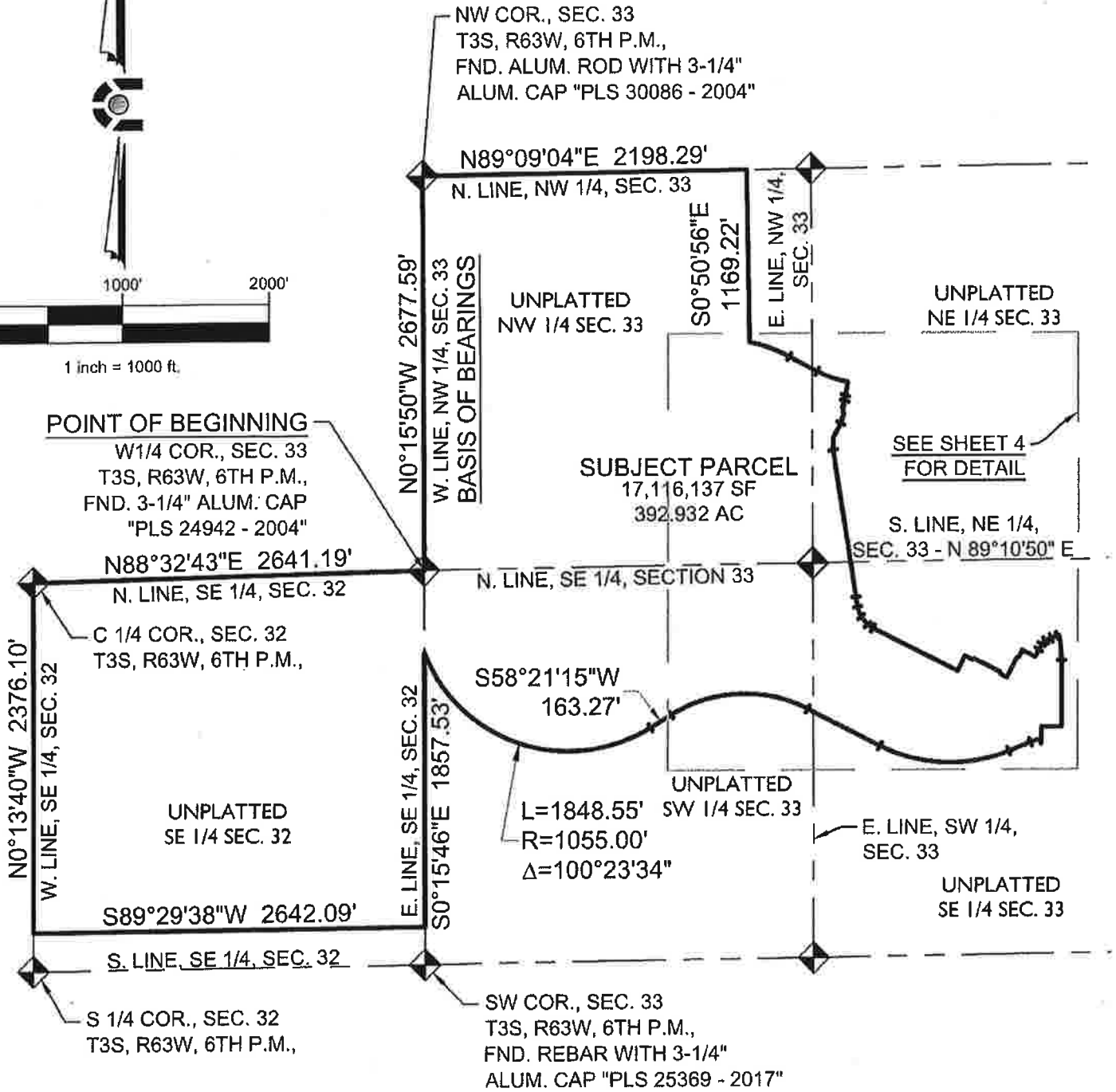
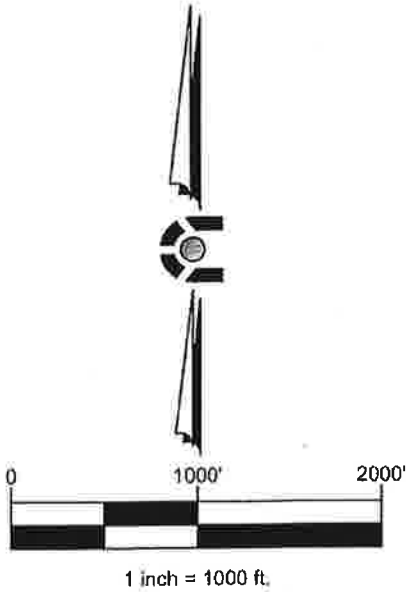

PARCEL CONTAINS 17,116,137 S.F. OR 392.932 Ac, MORE OR LESS.

NOTE: THIS DOES NOT REPRESENT A MONUMENTED SURVEY.  
IT IS INTENDED ONLY TO DEPICT THE ATTACHED DESCRIPTION

PROJECT: 18-131  
DATE: 02/24/2020  
SHEET 3 OF 5

DR: K. SIBLEY  
DS: T. GIRARD  
P.M. D. FORBES



**CORE**  
CONSULTANTS

CIVIL ENGINEERING  
DEVELOPMENT CONSULTING  
NATURAL RESOURCES  
LAND SURVEYING  
303.703.4444  
1950 W. Littleton Blvd., Ste. 109  
Littleton, CO 80120

# EXHIBIT

SECTIONS 32 AND 33, TOWNSHIP 3 SOUTH, RANGE 63 WEST OF THE 6TH P.M.,  
TOWN OF BENNETT, COUNTY OF ADAMS, STATE OF COLORADO

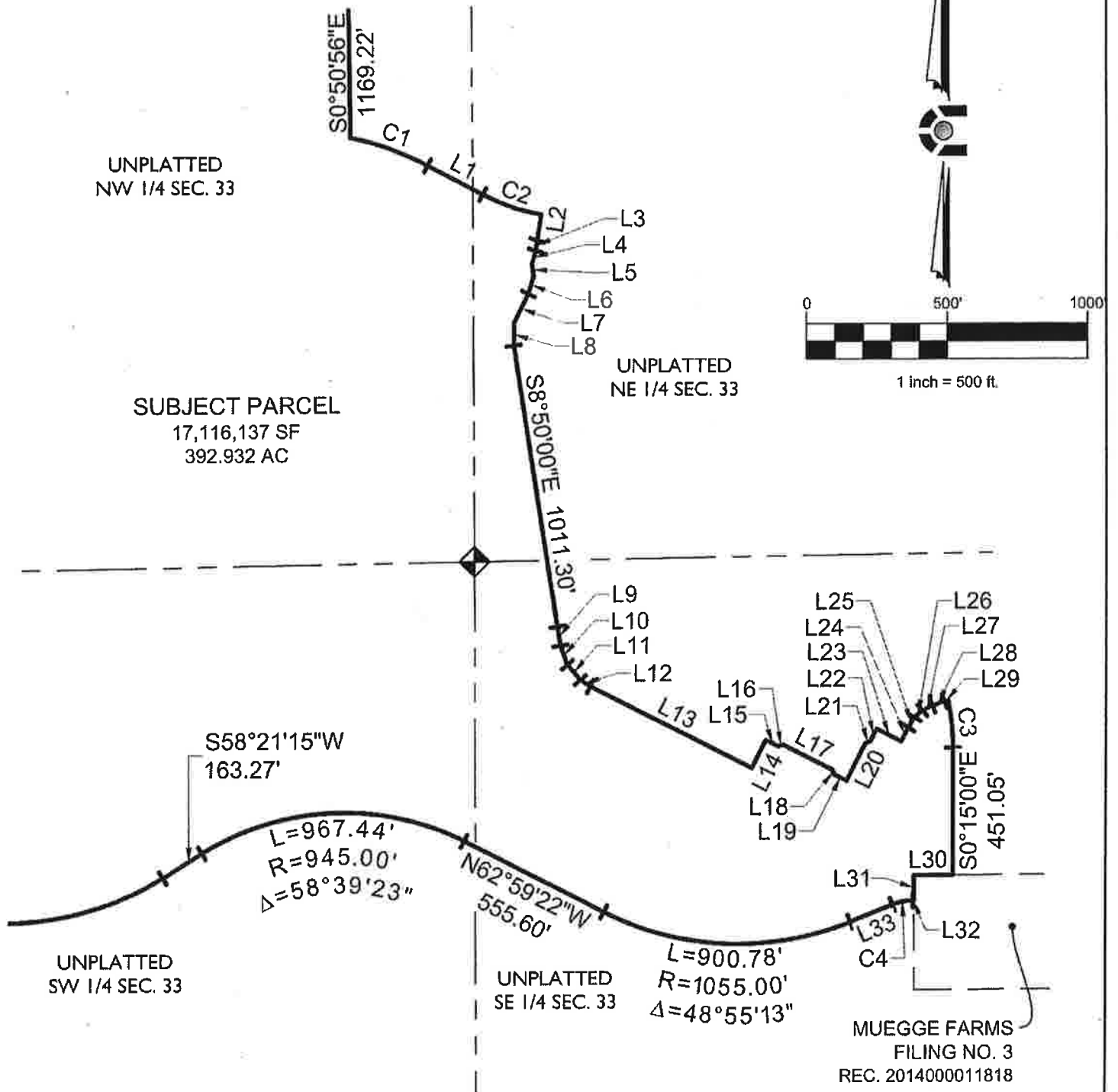

PARCEL CONTAINS 17,116,137 S.F. OR 392.932 Ac, MORE OR LESS.

NOTE: THIS DOES NOT REPRESENT A MONUMENTED SURVEY.  
IT IS INTENDED ONLY TO DEPICT THE ATTACHED DESCRIPTION

PROJECT: 18-131  
DATE: 02/24/2020  
SHEET 4 OF 5

DR: K. SIBLEY  
DS: T. GIRARD  
P.M. D. FORBES



**CORE**  
CONSULTANTS

CIVIL ENGINEERING  
DEVELOPMENT CONSULTING  
NATURAL RESOURCES  
LAND SURVEYING  
303.703.4444  
1950 W. Littleton Blvd., Ste. 109  
Littleton, CO 80120

# EXHIBIT

SECTIONS 32 AND 33, TOWNSHIP 3 SOUTH, RANGE 63 WEST OF THE 6TH P.M.,  
TOWN OF BENNETT, COUNTY OF ADAMS, STATE OF COLORADO

LINE TABLE		
LINE #	LENGTH	DIRECTION
L1	218.24'	S 61°59'52" E
L2	92.78'	S 8°26'35" W
L3	37.25'	S 8°32'42" W
L4	48.28'	S 16°33'10" W
L5	42.68'	S 8°50'00" E
L6	66.48'	S 16°40'28" W
L7	114.95'	S 26°36'18" W
L8	80.21'	S 0°17'37" W
L9	68.92'	S 8°51'07" E
L10	71.26'	S 19°57'27" E
L11	71.51'	S 40°31'03" E
L12	42.42'	S 56°54'09" E
L13	642.39'	S 62°59'22" E
L14	110.98'	N 27°00'38" E
L15	50.00'	S 62°59'28" E
L16	17.00'	N 72°00'41" E
L17	195.96'	S 62°59'22" E

LINE TABLE		
LINE #	LENGTH	DIRECTION
L18	16.97'	S 17°58'53" E
L19	50.02'	S 62°59'22" E
L20	149.98'	N 27°00'38" E
L21	16.97'	N 72°00'38" E
L22	50.00'	N 27°00'38" E
L23	98.00'	S 62°59'22" E
L24	55.00'	N 27°00'38" E
L25	41.14'	N 30°39'38" E
L26	37.99'	N 48°48'56" E
L27	40.38'	N 66°21'33" E
L28	45.00'	N 69°22'09" E
L29	12.98'	N 78°34'45" E
L30	139.44'	S 89°45'00" W
L31	90.00'	S 0°15'00" E
L32	3.26'	S 89°45'00" W
L33	161.00'	S 68°05'24" W

CURVE TABLE					
CURVE #	LENGTH	RADIUS	DELTA	CHORD BEARING	CHORD LENGTH
C1	290.29'	1055.00'	15°45'55"	S69°52'50"E	289.38'
C2	219.48'	695.00'	18°05'38"	S71°02'41"E	218.57'
C3	168.16'	862.50'	11°10'15"	S5°50'08"E	167.89'
C4	75.61'	200.00'	21°39'36"	S78°55'12"W	75.16'

NOTE: THIS DOES NOT REPRESENT A MONUMENTED SURVEY.  
IT IS INTENDED ONLY TO DEPICT THE ATTACHED DESCRIPTION

PROJECT: 18-131  
DATE: 02/24/2020  
SHEET 5 OF 5

DR: K. SIBLEY  
DS: T. GIRARD  
P.M. D. FORBES



CORE

CONSULTANTS

CIVIL ENGINEERING  
DEVELOPMENT CONSULTING  
NATURAL RESOURCES  
LAND SURVEYING

303.703.4444  
1950 W. Littleton Blvd., Ste. 109  
Littleton, CO 80120

**EXHIBIT D**  
**Financial Plan**





**MUEGGE FARMS METROPOLITAN DISTRICTS 1-8**

Development Projection at 55.664 (target) District Mills -- 02/12/2020

Series 2020, 2023 & 2026, G.O. Bonds, Non-Rated, 100x, 30-yr. Maturity

YEAR	Net Available for Debt Svc	Ser. 2020 \$30,480,000 Par [Net \$22,256 MM] Net Debt Service	Ser. 2023 \$31,560,000 Par [Net \$22,892 MM] Net Debt Service	Ser. 2026 \$27,810,000 Par [Net \$20,051 MM] Net Debt Service	Total Net Debt Service	Annual Surplus	Surplus Release to \$5,000,000	Cumulative Surplus \$5,000,000 Target	Senior Debt/Assessed Ratio	Senior Debt/Act'l Value Ratio
2019	0					0		0	n/a	n/a
2020	0	\$0				0	0	0	923%	13%
2021	191,004	0				191,004	0	191,004	266%	8%
2022	661,929	0			0	661,929	0	852,933	309%	12%
2023	1,140,883	0	\$0		0	1,140,883	0	1,993,816	213%	10%
2024	1,686,409	1,524,000	0	\$0	1,524,000	162,409	0	2,156,225	166%	9%
2025	2,161,236	1,524,000	0	0	1,524,000	637,236	0	2,793,461	190%	10%
2026	2,692,824	1,584,000	0	0	1,584,000	1,108,824	0	3,902,285	170%	10%
2027	3,053,911	1,581,000	1,578,000	0	3,159,000	(105,089)	0	3,797,196	144%	9%
2028	3,595,467	1,678,000	1,578,000	0	3,256,000	339,467	0	4,136,663	133%	9%
2029	3,882,662	1,680,000	1,578,000	0	3,258,000	624,682	0	4,761,345	123%	8%
2030	4,203,253	1,776,500	1,578,000	1,390,500	4,745,000	(541,747)	0	4,219,598	123%	8%
2031	4,203,253	1,777,750	1,578,000	1,390,500	4,746,250	(542,997)	0	3,676,601	115%	8%
2032	4,455,448	1,883,250	1,593,000	1,390,500	4,866,750	(411,302)	0	3,265,300	115%	8%
2033	4,455,448	1,882,750	1,592,250	1,390,500	4,865,500	(410,052)	0	2,855,248	108%	7%
2034	4,722,775	1,998,250	1,691,500	1,390,500	5,078,250	(355,475)	0	2,499,773	107%	7%
2035	4,722,775	1,998,000	1,685,750	1,390,500	5,074,250	(351,475)	0	2,148,298	100%	7%
2036	5,006,142	2,118,250	1,790,000	1,390,500	5,298,750	(292,608)	0	1,855,690	99%	7%
2037	5,006,142	2,121,000	1,783,750	1,390,500	5,295,250	(289,108)	0	1,566,582	92%	6%
2038	5,306,510	2,246,750	1,892,250	1,390,500	5,529,500	(222,990)	0	1,343,592	91%	6%
2039	5,306,510	2,244,250	1,894,750	1,390,500	5,529,500	(222,990)	0	1,120,602	84%	6%
2040	5,624,901	2,379,500	2,011,250	1,390,500	5,781,250	(156,349)	0	964,253	82%	6%
2041	5,624,901	2,380,500	2,011,000	1,390,500	5,782,000	(157,099)	0	807,154	76%	5%
2042	5,962,395	2,523,500	2,129,500	1,390,500	6,043,500	(81,105)	0	726,048	74%	5%
2043	5,962,395	2,528,250	2,125,750	1,390,500	6,042,500	(80,105)	0	645,943	68%	5%
2044	6,320,139	2,675,250	2,255,500	1,390,500	6,321,250	(1,111)	0	644,832	65%	4%
2045	6,320,139	2,673,000	2,262,000	1,390,500	6,325,500	(5,361)	0	639,470	59%	4%
2046	6,699,347	2,836,500	2,391,000	1,470,500	6,698,000	1,347	0	640,817	57%	4%
2047	6,699,347	2,837,250	2,391,250	1,466,500	6,695,000	4,347	0	645,164	51%	3%
2048	7,101,308	3,007,750	2,533,750	1,557,500	7,098,000	2,308	0	647,472	47%	3%
2049	7,101,308	3,004,250	2,536,250	1,558,750	7,099,250	2,058	0	649,529	41%	3%
2050	7,527,386	3,187,615	2,690,250	1,644,500	7,522,365	5,022	0	654,551	36%	2%
2051	7,527,386	0	5,873,500	1,650,500	7,523,500	-3,886	0	658,437	30%	2%
2052	7,979,029	0	6,227,500	1,750,500	7,978,000	1,029	0	659,466	25%	2%
2053	7,979,029	0	6,229,198	1,744,750	7,973,948	5,081	0	664,548	18%	1%
2054	8,457,771	0	0	8,453,250	8,453,250	4,521	0	669,069	13%	1%
2055	8,457,771	0	0	8,455,250	8,455,250	2,521	0	671,590	7%	0%
2056	8,965,237	0	0	8,963,250	8,963,250	1,987	673,577	0	0%	0%
	186,764,390	59,647,115	65,480,448	60,963,250	186,090,813	673,577	673,577			

[ NFebr1220 20spIn ] [ NFebr1220 26spIn ] [ NFebr1220 26spIn ]

**MUEGGE FARMS METROPOLITAN DISTRICTS 1-8**  
Operations Revenue and Expense Projection

YEAR	Total Assessed Value	Oper'n's Mill Levy	Total Collections @ 98%	Specific Ownership Tax @ 6%	Total Available For O&M	Total Mills
2019	0					
2020	0	11.056	0	0	0	66.720
2021	3,303,216	11.056	35,790	2,147	37,937	66.720
2022	11,447,352	11.056	124,031	7,442	131,473	66.720
2023	19,730,347	11.056	213,776	12,827	226,602	66.720
2024	29,164,629	11.056	315,995	18,960	334,955	66.720
2025	37,376,257	11.056	404,967	24,298	429,265	66.720
2026	46,569,510	11.056	504,575	30,275	534,850	66.720
2027	52,814,121	11.056	572,235	34,334	606,569	66.720
2028	62,179,740	11.056	673,710	40,423	714,133	66.720
2029	67,146,829	11.056	727,528	43,652	771,180	66.720
2030	72,690,757	11.056	787,596	47,256	834,851	66.720
2031	72,690,757	11.056	787,596	47,256	834,851	66.720
2032	77,052,202	11.056	834,851	50,091	884,942	66.720
2033	77,052,202	11.056	834,851	50,091	884,942	66.720
2034	81,675,334	11.056	884,942	53,087	938,039	66.720
2035	81,675,334	11.056	884,942	53,087	938,039	66.720
2036	86,575,854	11.056	938,039	56,282	994,321	66.720
2037	86,575,854	11.056	938,039	56,282	994,321	66.720
2038	91,770,405	11.056	994,321	59,659	1,053,981	66.720
2039	91,770,405	11.056	994,321	59,659	1,053,981	66.720
2040	97,276,630	11.056	1,053,981	63,239	1,117,219	66.720
2041	97,276,630	11.056	1,053,981	63,239	1,117,219	66.720
2042	103,113,228	11.056	1,117,219	67,033	1,184,253	66.720
2043	103,113,228	11.056	1,117,219	67,033	1,184,253	66.720
2044	109,300,021	11.056	1,184,253	71,055	1,255,308	66.720
2045	109,300,021	11.056	1,184,253	71,055	1,255,308	66.720
2046	115,858,022	11.056	1,255,308	75,318	1,330,626	66.720
2047	115,858,022	11.056	1,255,308	75,318	1,330,626	66.720
2048	122,809,504	11.056	1,330,626	79,838	1,410,464	66.720
2049	122,809,504	11.056	1,330,626	79,838	1,410,464	66.720
2050	130,178,074	11.056	1,410,464	84,628	1,495,092	66.720
2051	130,178,074	11.056	1,410,464	84,628	1,495,092	66.720
2052	137,988,759	11.056	1,495,092	89,705	1,584,797	66.720
2053	137,988,759	11.056	1,495,092	89,705	1,584,797	66.720
2054	146,268,084	11.056	1,584,797	95,088	1,679,885	66.720
2055	146,268,084	11.056	1,584,797	95,088	1,679,885	66.720
2056	155,044,169	11.056	1,679,885	100,793	1,780,678	66.720
			34,995,470	2,099,728	37,095,198	



**SOURCES AND USES OF FUNDS**

**MUEGGE FARMS METROPOLITAN DISTRICTS 1-8  
 GENERAL OBLIGATION BONDS, SERIES 2020  
 55.664 (target) Mills  
 Non-Rated, 100x, 2050 Final Maturity  
 [ Preliminary -- for discussion only ]**

Dated Date                    12/01/2020  
 Delivery Date                12/01/2020

**Sources:**

<b>Bond Proceeds:</b>	
Par Amount	30,480,000.00
	<u>30,480,000.00</u>

**Uses:**

<b>Project Fund Deposits:</b>	
Project Fund	22,256,264.58
<b>Other Fund Deposits:</b>	
Capitalized Interest Fund	4,572,000.00
Debt Service Reserve	<u>2,792,135.42</u>
	7,364,135.42
<b>Cost of Issuance:</b>	
Other Cost of Issuance	250,000.00
<b>Delivery Date Expenses:</b>	
Underwriter's Discount	609,600.00
	<u>30,480,000.00</u>

**BOND SUMMARY STATISTICS**

**MUEGGE FARMS METROPOLITAN DISTRICTS 1-8  
GENERAL OBLIGATION BONDS, SERIES 2020**

**55.664 (target) Mills**

**Non-Rated, 100x, 2050 Final Maturity  
[ Preliminary -- for discussion only ]**

Dated Date	12/01/2020
Delivery Date	12/01/2020
First Coupon	06/01/2021
Last Maturity	12/01/2050
Arbitrage Yield	5.000000%
True Interest Cost (TIC)	5.149011%
Net Interest Cost (NIC)	5.000000%
All-In TIC	5.211402%
Average Coupon	5.000000%
Average Life (years)	23.971
Weighted Average Maturity (years)	23.971
Duration of Issue (years)	13.844
Par Amount	30,480,000.00
Bond Proceeds	30,480,000.00
Total Interest	36,531,250.00
Net Interest	37,140,850.00
Bond Years from Dated Date	730,625,000.00
Bond Years from Delivery Date	730,625,000.00
Total Debt Service	67,011,250.00
Maximum Annual Debt Service	5,979,750.00
Average Annual Debt Service	2,233,708.33
Underwriter's Fees (per \$1000)	
Average Takedown	
Other Fee	20.000000
Total Underwriter's Discount	20.000000
Bid Price	98.000000

Bond Component	Par Value	Price	Average Coupon	Average Life	Average Maturity Date	PV of 1 bp change
Term Bond due 2050	30,480,000.00	100.000	5.000%	23.971	11/20/2044	47,244.00
	30,480,000.00			23.971		47,244.00

	TIC	All-In TIC	Arbitrage Yield
Par Value	30,480,000.00	30,480,000.00	30,480,000.00
+ Accrued Interest			
+ Premium (Discount)			
- Underwriter's Discount	-609,600.00	-609,600.00	
- Cost of Issuance Expense		-250,000.00	
- Other Amounts			
Target Value	29,870,400.00	29,620,400.00	30,480,000.00
Target Date	12/01/2020	12/01/2020	12/01/2020
Yield	5.149011%	5.211402%	5.000000%

**BOND DEBT SERVICE**  
**MUEGGE FARMS METROPOLITAN DISTRICTS 1-8**  
**GENERAL OBLIGATION BONDS, SERIES 2020**  
**55.664 (target) Mills**  
**Non-Rated, 100x, 2050 Final Maturity**  
**[ Preliminary -- for discussion only ]**

Period Ending	Principal	Coupon	Interest	Debt Service	Annual Debt Service
06/01/2021			762,000	762,000	
12/01/2021			762,000	762,000	1,524,000
06/01/2022			762,000	762,000	
12/01/2022			762,000	762,000	1,524,000
06/01/2023			762,000	762,000	
12/01/2023			762,000	762,000	1,524,000
06/01/2024			762,000	762,000	
12/01/2024			762,000	762,000	1,524,000
06/01/2025			762,000	762,000	
12/01/2025			762,000	762,000	1,524,000
06/01/2026			762,000	762,000	
12/01/2026	60,000	5.000%	762,000	822,000	1,584,000
06/01/2027			760,500	760,500	
12/01/2027	60,000	5.000%	760,500	820,500	1,581,000
06/01/2028			759,000	759,000	
12/01/2028	160,000	5.000%	759,000	919,000	1,678,000
06/01/2029			755,000	755,000	
12/01/2029	170,000	5.000%	755,000	925,000	1,680,000
06/01/2030			750,750	750,750	
12/01/2030	275,000	5.000%	750,750	1,025,750	1,776,500
06/01/2031			743,875	743,875	
12/01/2031	290,000	5.000%	743,875	1,033,875	1,777,750
06/01/2032			736,625	736,625	
12/01/2032	410,000	5.000%	736,625	1,146,625	1,883,250
06/01/2033			726,375	726,375	
12/01/2033	430,000	5.000%	726,375	1,156,375	1,882,750
06/01/2034			715,625	715,625	
12/01/2034	565,000	5.000%	715,625	1,280,625	1,996,250
06/01/2035			701,500	701,500	
12/01/2035	595,000	5.000%	701,500	1,296,500	1,998,000
06/01/2036			686,625	686,625	
12/01/2036	745,000	5.000%	686,625	1,431,625	2,118,250
06/01/2037			668,000	668,000	
12/01/2037	785,000	5.000%	668,000	1,453,000	2,121,000
06/01/2038			648,375	648,375	
12/01/2038	950,000	5.000%	648,375	1,598,375	2,246,750
06/01/2039			624,625	624,625	
12/01/2039	995,000	5.000%	624,625	1,619,625	2,244,250
06/01/2040			599,750	599,750	
12/01/2040	1,180,000	5.000%	599,750	1,779,750	2,379,500
06/01/2041			570,250	570,250	
12/01/2041	1,240,000	5.000%	570,250	1,810,250	2,380,500
06/01/2042			539,250	539,250	
12/01/2042	1,445,000	5.000%	539,250	1,984,250	2,523,500
06/01/2043			503,125	503,125	
12/01/2043	1,520,000	5.000%	503,125	2,023,125	2,526,250
06/01/2044			465,125	465,125	
12/01/2044	1,745,000	5.000%	465,125	2,210,125	2,675,250
06/01/2045			421,500	421,500	
12/01/2045	1,830,000	5.000%	421,500	2,251,500	2,673,000
06/01/2046			375,750	375,750	
12/01/2046	2,085,000	5.000%	375,750	2,460,750	2,836,500
06/01/2047			323,625	323,625	
12/01/2047	2,190,000	5.000%	323,625	2,513,625	2,837,250
06/01/2048			268,875	268,875	
12/01/2048	2,470,000	5.000%	268,875	2,738,875	3,007,750
06/01/2049			207,125	207,125	
12/01/2049	2,590,000	5.000%	207,125	2,797,125	3,004,250
06/01/2050			142,375	142,375	
12/01/2050	5,695,000	5.000%	142,375	5,837,375	5,979,750
	30,480,000		36,531,250	67,011,250	67,011,250

**NET DEBT SERVICE**

**MUEGGE FARMS METROPOLITAN DISTRICTS 1-8  
 GENERAL OBLIGATION BONDS, SERIES 2020  
 55.664 (target) Mills  
 Non-Rated, 100x, 2050 Final Maturity  
 [ Preliminary -- for discussion only ]**

Period Ending	Principal	Interest	Total Debt Service	Debt Service Reserve	Capitalized Interest Fund	Net Debt Service
12/01/2021		1,524,000	1,524,000		1,524,000	
12/01/2022		1,524,000	1,524,000		1,524,000	
12/01/2023		1,524,000	1,524,000		1,524,000	
12/01/2024		1,524,000	1,524,000			1,524,000.00
12/01/2025		1,524,000	1,524,000			1,524,000.00
12/01/2026	60,000	1,524,000	1,584,000			1,584,000.00
12/01/2027	60,000	1,521,000	1,581,000			1,581,000.00
12/01/2028	160,000	1,518,000	1,678,000			1,678,000.00
12/01/2029	170,000	1,510,000	1,680,000			1,680,000.00
12/01/2030	275,000	1,501,500	1,776,500			1,776,500.00
12/01/2031	290,000	1,487,750	1,777,750			1,777,750.00
12/01/2032	410,000	1,473,250	1,883,250			1,883,250.00
12/01/2033	430,000	1,452,750	1,882,750			1,882,750.00
12/01/2034	565,000	1,431,250	1,996,250			1,996,250.00
12/01/2035	595,000	1,403,000	1,998,000			1,998,000.00
12/01/2036	745,000	1,373,250	2,118,250			2,118,250.00
12/01/2037	785,000	1,336,000	2,121,000			2,121,000.00
12/01/2038	950,000	1,296,750	2,246,750			2,246,750.00
12/01/2039	995,000	1,249,250	2,244,250			2,244,250.00
12/01/2040	1,180,000	1,199,500	2,379,500			2,379,500.00
12/01/2041	1,240,000	1,140,500	2,380,500			2,380,500.00
12/01/2042	1,445,000	1,078,500	2,523,500			2,523,500.00
12/01/2043	1,520,000	1,006,250	2,526,250			2,526,250.00
12/01/2044	1,745,000	930,250	2,675,250			2,675,250.00
12/01/2045	1,830,000	843,000	2,673,000			2,673,000.00
12/01/2046	2,085,000	751,500	2,836,500			2,836,500.00
12/01/2047	2,190,000	647,250	2,837,250			2,837,250.00
12/01/2048	2,470,000	537,750	3,007,750			3,007,750.00
12/01/2049	2,590,000	414,250	3,004,250			3,004,250.00
12/01/2050	5,695,000	284,750	5,979,750	2,792,135.42		3,187,614.58
	30,480,000	36,531,250	67,011,250	2,792,135.42	4,572,000	59,647,114.58



**BOND SOLUTION**

**MUEGGE FARMS METROPOLITAN DISTRICTS 1-8  
 GENERAL OBLIGATION BONDS, SERIES 2020  
 55.664 (target) Mills**

**Non-Rated, 100x, 2050 Final Maturity  
 [ Preliminary -- for discussion only ]**

Period Ending	Proposed Principal	Proposed Debt Service	Debt Service Adjustments	Total Adj Debt Service	Revenue Constraints	Unused Revenues	Debt Serv Coverage
12/01/2021		1,524,000	-1,524,000		191,004	191,004	
12/01/2022		1,524,000	-1,524,000		661,929	661,929	
12/01/2023		1,524,000	-1,524,000		1,140,883	1,140,883	
12/01/2024		1,524,000		1,524,000	1,495,404	-28,596	98.12364%
12/01/2025		1,524,000		1,524,000	1,495,404	-28,596	98.12364%
12/01/2026	60,000	1,584,000		1,584,000	1,585,128	1,128	100.07124%
12/01/2027	60,000	1,581,000		1,581,000	1,585,128	4,128	100.26113%
12/01/2028	160,000	1,678,000		1,678,000	1,680,236	2,236	100.13327%
12/01/2029	170,000	1,680,000		1,680,000	1,680,236	236	100.01406%
12/01/2030	275,000	1,776,500		1,776,500	1,781,050	4,550	100.25614%
12/01/2031	290,000	1,777,750		1,777,750	1,781,050	3,300	100.18565%
12/01/2032	410,000	1,883,250		1,883,250	1,887,913	4,663	100.24762%
12/01/2033	430,000	1,882,750		1,882,750	1,887,913	5,163	100.27425%
12/01/2034	565,000	1,996,250		1,996,250	2,001,188	4,938	100.24737%
12/01/2035	595,000	1,998,000		1,998,000	2,001,188	3,188	100.15957%
12/01/2036	745,000	2,118,250		2,118,250	2,121,259	3,009	100.14207%
12/01/2037	785,000	2,121,000		2,121,000	2,121,259	259	100.01223%
12/01/2038	950,000	2,246,750		2,246,750	2,248,535	1,785	100.07945%
12/01/2039	995,000	2,244,250		2,244,250	2,248,535	4,285	100.19093%
12/01/2040	1,180,000	2,379,500		2,379,500	2,383,447	3,947	100.16588%
12/01/2041	1,240,000	2,380,500		2,380,500	2,383,447	2,947	100.12380%
12/01/2042	1,445,000	2,523,500		2,523,500	2,526,454	2,954	100.11706%
12/01/2043	1,520,000	2,526,250		2,526,250	2,526,454	204	100.00807%
12/01/2044	1,745,000	2,675,250		2,675,250	2,678,041	2,791	100.10433%
12/01/2045	1,830,000	2,673,000		2,673,000	2,678,041	5,041	100.18860%
12/01/2046	2,085,000	2,836,500		2,836,500	2,838,724	2,224	100.07840%
12/01/2047	2,190,000	2,837,250		2,837,250	2,838,724	1,474	100.05194%
12/01/2048	2,470,000	3,007,750		3,007,750	3,009,047	1,297	100.04313%
12/01/2049	2,590,000	3,004,250		3,004,250	3,009,047	4,797	100.15968%
12/01/2050	5,695,000	5,979,750	-2,792,135	3,187,615	3,189,590	1,975	100.06197%
	<b>30,480,000</b>	<b>67,011,250</b>	<b>-7,364,135</b>	<b>59,647,115</b>	<b>61,656,263</b>	<b>2,009,149</b>	

**SOURCES AND USES OF FUNDS**

**MUEGGE FARMS METROPOLITAN DISTRICTS 1-8  
GENERAL OBLIGATION BONDS, SERIES 2023**

**55.664 (target) Mills**

**Non-Rated, 100x, 2053 Final Maturity**

**[ Preliminary -- for discussion only ]**

Dated Date	12/01/2023
Delivery Date	12/01/2023

**Sources:**

<b>Bond Proceeds:</b>	
Par Amount	31,560,000.00
	<u>31,560,000.00</u>

**Uses:**

<b>Project Fund Deposits:</b>	
Project Fund	22,891,997.92
<b>Other Fund Deposits:</b>	
Capitalized Interest Fund	4,734,000.00
Debt Service Reserve	<u>3,052,802.08</u>
	7,786,802.08
<b>Cost of Issuance:</b>	
Other Cost of Issuance	250,000.00
<b>Delivery Date Expenses:</b>	
Underwriter's Discount	631,200.00
	<u>31,560,000.00</u>

**BOND SUMMARY STATISTICS**

**MUEGGE FARMS METROPOLITAN DISTRICTS 1-8  
GENERAL OBLIGATION BONDS, SERIES 2023**

**55.664 (target) Mills**

**Non-Rated, 100x, 2053 Final Maturity  
[ Preliminary -- for discussion only ]**

Dated Date	12/01/2023
Delivery Date	12/01/2023
First Coupon	06/01/2024
Last Maturity	12/01/2053
Arbitrage Yield	5.000000%
True Interest Cost (TIC)	5.140580%
Net Interest Cost (NIC)	5.000000%
All-In TIC	5.197421%
Average Coupon	5.000000%
Average Life (years)	26.430
Weighted Average Maturity (years)	26.430
Duration of Issue (years)	14.673
Par Amount	31,560,000.00
Bond Proceeds	31,560,000.00
Total Interest	41,707,250.00
Net Interest	42,338,450.00
Bond Years from Dated Date	834,145,000.00
Bond Years from Delivery Date	834,145,000.00
Total Debt Service	73,267,250.00
Maximum Annual Debt Service	9,282,000.00
Average Annual Debt Service	2,442,241.67
Underwriter's Fees (per \$1000)	
Average Takedown	
Other Fee	20.000000
Total Underwriter's Discount	20.000000
Bid Price	98.000000

Bond Component	Par Value	Price	Average Coupon	Average Life	Average Maturity Date	PV of 1 bp change
Term Bond due 2053	31,560,000.00	100.000	5.000%	26.430	05/06/2050	48,918.00
	31,560,000.00			26.430		48,918.00

	TIC	All-In TIC	Arbitrage Yield
Par Value	31,560,000.00	31,560,000.00	31,560,000.00
+ Accrued Interest			
+ Premium (Discount)			
- Underwriter's Discount	-631,200.00	-631,200.00	
- Cost of Issuance Expense		-250,000.00	
- Other Amounts			
Target Value	30,928,800.00	30,678,800.00	31,560,000.00
Target Date	12/01/2023	12/01/2023	12/01/2023
Yield	5.140580%	5.197421%	5.000000%

**BOND DEBT SERVICE**  
**MUEGGE FARMS METROPOLITAN DISTRICTS 1-8**  
**GENERAL OBLIGATION BONDS, SERIES 2023**  
**55.664 (target) Mills**  
**Non-Rated, 100x, 2053 Final Maturity**  
**[ Preliminary -- for discussion only ]**

Period Ending	Principal	Coupon	Interest	Debt Service	Annual Debt Service
06/01/2024			789,000	789,000	
12/01/2024			789,000	789,000	1,578,000
06/01/2025			789,000	789,000	
12/01/2025			789,000	789,000	1,578,000
06/01/2026			789,000	789,000	
12/01/2026			789,000	789,000	1,578,000
06/01/2027			789,000	789,000	
12/01/2027			789,000	789,000	1,578,000
06/01/2028			789,000	789,000	
12/01/2028			789,000	789,000	1,578,000
06/01/2029			789,000	789,000	
12/01/2029			789,000	789,000	1,578,000
06/01/2030			789,000	789,000	
12/01/2030			789,000	789,000	1,578,000
06/01/2031			789,000	789,000	
12/01/2031			789,000	789,000	1,578,000
06/01/2032			789,000	789,000	
12/01/2032	15,000	5.000%	789,000	804,000	1,593,000
06/01/2033			788,625	788,625	
12/01/2033	15,000	5.000%	788,625	803,625	1,592,250
06/01/2034			788,250	788,250	
12/01/2034	115,000	5.000%	788,250	903,250	1,691,500
06/01/2035			785,375	785,375	
12/01/2035	115,000	5.000%	785,375	900,375	1,685,750
06/01/2036			782,500	782,500	
12/01/2036	225,000	5.000%	782,500	1,007,500	1,790,000
06/01/2037			776,875	776,875	
12/01/2037	230,000	5.000%	776,875	1,006,875	1,783,750
06/01/2038			771,125	771,125	
12/01/2038	350,000	5.000%	771,125	1,121,125	1,892,250
06/01/2039			762,375	762,375	
12/01/2039	370,000	5.000%	762,375	1,132,375	1,894,750
06/01/2040			753,125	753,125	
12/01/2040	505,000	5.000%	753,125	1,258,125	2,011,250
06/01/2041			740,500	740,500	
12/01/2041	530,000	5.000%	740,500	1,270,500	2,011,000
06/01/2042			727,250	727,250	
12/01/2042	675,000	5.000%	727,250	1,402,250	2,129,500
06/01/2043			710,375	710,375	
12/01/2043	705,000	5.000%	710,375	1,415,375	2,125,750
06/01/2044			692,750	692,750	
12/01/2044	870,000	5.000%	692,750	1,562,750	2,255,500
06/01/2045			671,000	671,000	
12/01/2045	920,000	5.000%	671,000	1,591,000	2,262,000
06/01/2046			648,000	648,000	
12/01/2046	1,095,000	5.000%	648,000	1,743,000	2,391,000
06/01/2047			620,625	620,625	
12/01/2047	1,150,000	5.000%	620,625	1,770,625	2,391,250
06/01/2048			591,875	591,875	
12/01/2048	1,350,000	5.000%	591,875	1,941,875	2,533,750
06/01/2049			558,125	558,125	
12/01/2049	1,420,000	5.000%	558,125	1,978,125	2,536,250
06/01/2050			522,625	522,625	
12/01/2050	1,645,000	5.000%	522,625	2,167,625	2,690,250
06/01/2051			481,500	481,500	
12/01/2051	4,910,000	5.000%	481,500	5,391,500	5,873,000
06/01/2052			358,750	358,750	
12/01/2052	5,510,000	5.000%	358,750	5,868,750	6,227,500
06/01/2053			221,000	221,000	
12/01/2053	8,840,000	5.000%	221,000	9,061,000	9,282,000
	31,560,000		41,707,250	73,267,250	73,267,250

**NET DEBT SERVICE**

**MUEGGE FARMS METROPOLITAN DISTRICTS 1-8  
GENERAL OBLIGATION BONDS, SERIES 2023**

**55.664 (target) Mills**

**Non-Rated, 100x, 2053 Final Maturity**

**[ Preliminary -- for discussion only ]**

Period Ending	Principal	Interest	Total Debt Service	Debt Service Reserve	Capitalized Interest Fund	Net Debt Service
12/01/2024		1,578,000	1,578,000		1,578,000	
12/01/2025		1,578,000	1,578,000		1,578,000	
12/01/2026		1,578,000	1,578,000		1,578,000	
12/01/2027		1,578,000	1,578,000			1,578,000.00
12/01/2028		1,578,000	1,578,000			1,578,000.00
12/01/2029		1,578,000	1,578,000			1,578,000.00
12/01/2030		1,578,000	1,578,000			1,578,000.00
12/01/2031		1,578,000	1,578,000			1,578,000.00
12/01/2032	15,000	1,578,000	1,593,000			1,593,000.00
12/01/2033	15,000	1,577,250	1,592,250			1,592,250.00
12/01/2034	115,000	1,576,500	1,691,500			1,691,500.00
12/01/2035	115,000	1,570,750	1,685,750			1,685,750.00
12/01/2036	225,000	1,565,000	1,790,000			1,790,000.00
12/01/2037	230,000	1,553,750	1,783,750			1,783,750.00
12/01/2038	350,000	1,542,250	1,892,250			1,892,250.00
12/01/2039	370,000	1,524,750	1,894,750			1,894,750.00
12/01/2040	505,000	1,506,250	2,011,250			2,011,250.00
12/01/2041	530,000	1,481,000	2,011,000			2,011,000.00
12/01/2042	675,000	1,454,500	2,129,500			2,129,500.00
12/01/2043	705,000	1,420,750	2,125,750			2,125,750.00
12/01/2044	870,000	1,385,500	2,255,500			2,255,500.00
12/01/2045	920,000	1,342,000	2,262,000			2,262,000.00
12/01/2046	1,095,000	1,296,000	2,391,000			2,391,000.00
12/01/2047	1,150,000	1,241,250	2,391,250			2,391,250.00
12/01/2048	1,350,000	1,183,750	2,533,750			2,533,750.00
12/01/2049	1,420,000	1,116,250	2,536,250			2,536,250.00
12/01/2050	1,645,000	1,045,250	2,690,250			2,690,250.00
12/01/2051	4,910,000	963,000	5,873,000			5,873,000.00
12/01/2052	5,510,000	717,500	6,227,500			6,227,500.00
12/01/2053	8,840,000	442,000	9,282,000	3,052,802.08		6,229,197.92
	31,560,000	41,707,250	73,267,250	3,052,802.08	4,734,000	65,480,447.92

**BOND SOLUTION**

**MUEGGE FARMS METROPOLITAN DISTRICTS 1-8  
GENERAL OBLIGATION BONDS, SERIES 2023**

**55.664 (target) Mills**

**Non-Rated, 100x, 2053 Final Maturity  
[ Preliminary -- for discussion only ]**

Period Ending	Proposed Principal	Proposed Debt Service	Debt Service Adjustments	Existing Debt Service	Total Adj Debt Service	Revenue Constraints	Unused Revenues	Debt Serv Coverage
12/01/2024		1,578,000	-1,578,000	1,524,000	1,524,000	1,686,409	162,409	110.65673%
12/01/2025		1,578,000	-1,578,000	1,524,000	1,524,000	2,161,236	637,236	141.81337%
12/01/2026		1,578,000	-1,578,000	1,584,000	1,584,000	2,692,824	1,108,824	170.00154%
12/01/2027		1,578,000		1,581,000	3,159,000	2,921,263	-237,737	92.47428%
12/01/2028		1,578,000		1,678,000	3,256,000	3,096,538	-159,462	95.10253%
12/01/2029		1,578,000		1,680,000	3,258,000	3,096,538	-161,462	95.04415%
12/01/2030		1,578,000		1,776,500	3,354,500	3,282,331	-72,169	97.84858%
12/01/2031		1,578,000		1,777,750	3,355,750	3,282,331	-73,419	97.81213%
12/01/2032	15,000	1,593,000		1,883,250	3,476,250	3,479,270	3,020	100.08689%
12/01/2033	15,000	1,592,250		1,882,750	3,475,000	3,479,270	4,270	100.12289%
12/01/2034	115,000	1,691,500		1,996,250	3,687,750	3,688,027	277	100.00750%
12/01/2035	115,000	1,685,750		1,998,000	3,683,750	3,688,027	4,277	100.11610%
12/01/2036	225,000	1,790,000		2,118,250	3,908,250	3,909,308	1,058	100.02708%
12/01/2037	230,000	1,783,750		2,121,000	3,904,750	3,909,308	4,558	100.11674%
12/01/2038	350,000	1,892,250		2,246,750	4,139,000	4,143,867	4,867	100.11758%
12/01/2039	370,000	1,894,750		2,244,250	4,139,000	4,143,867	4,867	100.11758%
12/01/2040	505,000	2,011,250		2,379,500	4,390,750	4,392,499	1,749	100.03983%
12/01/2041	530,000	2,011,000		2,380,500	4,391,500	4,392,499	999	100.02274%
12/01/2042	675,000	2,129,500		2,523,500	4,653,000	4,656,049	3,049	100.06552%
12/01/2043	705,000	2,125,750		2,526,250	4,652,000	4,656,049	4,049	100.08703%
12/01/2044	870,000	2,255,500		2,675,250	4,930,750	4,935,412	4,662	100.09454%
12/01/2045	920,000	2,262,000		2,673,000	4,935,000	4,935,412	412	100.00834%
12/01/2046	1,095,000	2,391,000		2,836,500	5,227,500	5,231,536	4,036	100.07721%
12/01/2047	1,150,000	2,391,250		2,837,250	5,228,500	5,231,536	3,036	100.05807%
12/01/2048	1,350,000	2,533,750		3,007,750	5,541,500	5,545,429	3,929	100.07089%
12/01/2049	1,420,000	2,536,250		3,004,250	5,540,500	5,545,429	4,929	100.08895%
12/01/2050	1,645,000	2,690,250		3,187,615	5,877,865	5,878,154	290	100.00493%
12/01/2051	4,910,000	5,873,000		5,873,000	5,873,000	5,878,154	5,154	100.08776%
12/01/2052	5,510,000	6,227,500		6,227,500	6,227,500	6,230,844	3,344	100.05369%
12/01/2053	8,840,000	9,282,000	-3,052,802		6,229,198	6,230,844	1,646	100.02642%
	<b>31,560,000</b>	<b>73,267,250</b>	<b>-7,786,802</b>	<b>59,647,115</b>	<b>125,127,563</b>	<b>126,400,257</b>	<b>1,272,695</b>	

**SOURCES AND USES OF FUNDS**

**MUEGGE FARMS METROPOLITAN DISTRICTS 1-8  
 GENERAL OBLIGATION BONDS, SERIES 2026  
 55.664 (target) Mills**

**Non-Rated, 100x, 2056 Final Maturity  
 [ Preliminary -- for discussion only ]**

Dated Date                    12/01/2026  
 Delivery Date                12/01/2026

**Sources:**

<b>Bond Proceeds:</b>	
Par Amount	27,810,000.00
	<u>27,810,000.00</u>

**Uses:**

<b>Project Fund Deposits:</b>	
Project Fund	20,051,300.00
<b>Other Fund Deposits:</b>	
Capitalized Interest Fund	4,171,500.00
Debt Service Reserve	<u>2,781,000.00</u>
	6,952,500.00
<b>Cost of Issuance:</b>	
Other Cost of Issuance	250,000.00
<b>Delivery Date Expenses:</b>	
Underwriter's Discount	556,200.00
	<u>27,810,000.00</u>

### BOND SUMMARY STATISTICS

#### MUEGGE FARMS METROPOLITAN DISTRICTS 1-8 GENERAL OBLIGATION BONDS, SERIES 2026

55.664 (target) Mills

Non-Rated, 100x, 2056 Final Maturity  
[ Preliminary -- for discussion only ]

Dated Date	12/01/2026
Delivery Date	12/01/2026
First Coupon	06/01/2027
Last Maturity	12/01/2056
Arbitrage Yield	5.000000%
True Interest Cost (TIC)	5.133774%
Net Interest Cost (NIC)	5.000000%
All-In TIC	5.195215%
Average Coupon	5.000000%
Average Life (years)	28.843
Weighted Average Maturity (years)	28.843
Duration of Issue (years)	15.417
Par Amount	27,810,000.00
Bond Proceeds	27,810,000.00
Total Interest	40,105,750.00
Net Interest	40,661,950.00
Bond Years from Dated Date	802,115,000.00
Bond Years from Delivery Date	802,115,000.00
Total Debt Service	67,915,750.00
Maximum Annual Debt Service	11,744,250.00
Average Annual Debt Service	2,263,858.33
Underwriter's Fees (per \$1000)	
Average Takedown	
Other Fee	20.000000
Total Underwriter's Discount	20.000000
Bid Price	98.000000

Bond Component	Par Value	Price	Average Coupon	Average Life	Average Maturity Date	PV of 1 bp change
Term Bond due 2056	27,810,000.00	100.000	5.000%	28.843	10/04/2055	43,105.50
	27,810,000.00			28.843		43,105.50

	TIC	All-In TIC	Arbitrage Yield
Par Value	27,810,000.00	27,810,000.00	27,810,000.00
+ Accrued Interest			
+ Premium (Discount)			
- Underwriter's Discount	-556,200.00	-556,200.00	
- Cost of Issuance Expense		-250,000.00	
- Other Amounts			
Target Value	27,253,800.00	27,003,800.00	27,810,000.00
Target Date	12/01/2026	12/01/2026	12/01/2026
Yield	5.133774%	5.195215%	5.000000%



**BOND DEBT SERVICE**

**MUEGGE FARMS METROPOLITAN DISTRICTS 1-8**  
**GENERAL OBLIGATION BONDS, SERIES 2026**  
**55.664 (target) Mills**  
**Non-Rated, 100x, 2056 Final Maturity**  
**[ Preliminary -- for discussion only ]**

Period Ending	Principal	Coupon	Interest	Debt Service	Annual Debt Service
06/01/2027			695,250	695,250	
12/01/2027			695,250	695,250	1,390,500
06/01/2028			695,250	695,250	
12/01/2028			695,250	695,250	1,390,500
06/01/2029			695,250	695,250	
12/01/2029			695,250	695,250	1,390,500
06/01/2030			695,250	695,250	
12/01/2030			695,250	695,250	1,390,500
06/01/2031			695,250	695,250	
12/01/2031			695,250	695,250	1,390,500
06/01/2032			695,250	695,250	
12/01/2032			695,250	695,250	1,390,500
06/01/2033			695,250	695,250	
12/01/2033			695,250	695,250	1,390,500
06/01/2034			695,250	695,250	
12/01/2034			695,250	695,250	1,390,500
06/01/2035			695,250	695,250	
12/01/2035			695,250	695,250	1,390,500
06/01/2036			695,250	695,250	
12/01/2036			695,250	695,250	1,390,500
06/01/2037			695,250	695,250	
12/01/2037			695,250	695,250	1,390,500
06/01/2038			695,250	695,250	
12/01/2038			695,250	695,250	1,390,500
06/01/2039			695,250	695,250	
12/01/2039			695,250	695,250	1,390,500
06/01/2040			695,250	695,250	
12/01/2040			695,250	695,250	1,390,500
06/01/2041			695,250	695,250	
12/01/2041			695,250	695,250	1,390,500
06/01/2042			695,250	695,250	
12/01/2042			695,250	695,250	1,390,500
06/01/2043			695,250	695,250	
12/01/2043			695,250	695,250	1,390,500
06/01/2044			695,250	695,250	
12/01/2044			695,250	695,250	1,390,500
06/01/2045			695,250	695,250	
12/01/2045			695,250	695,250	1,390,500
06/01/2046			695,250	695,250	
12/01/2046	80,000	5.000%	695,250	775,250	1,470,500
06/01/2047			693,250	693,250	
12/01/2047	80,000	5.000%	693,250	773,250	1,466,500
06/01/2048			691,250	691,250	
12/01/2048	175,000	5.000%	691,250	866,250	1,557,500
06/01/2049			686,875	686,875	
12/01/2049	185,000	5.000%	686,875	871,875	1,558,750
06/01/2050			682,250	682,250	
12/01/2050	280,000	5.000%	682,250	962,250	1,644,500
06/01/2051			675,250	675,250	
12/01/2051	300,000	5.000%	675,250	975,250	1,650,500
06/01/2052			667,750	667,750	
12/01/2052	415,000	5.000%	667,750	1,082,750	1,750,500
06/01/2053			657,375	657,375	
12/01/2053	430,000	5.000%	657,375	1,087,375	1,744,750
06/01/2054			646,625	646,625	
12/01/2054	7,160,000	5.000%	646,625	7,806,625	8,453,250
06/01/2055			467,625	467,625	
12/01/2055	7,520,000	5.000%	467,625	7,987,625	8,455,250
06/01/2056			279,625	279,625	
12/01/2056	11,185,000	5.000%	279,625	11,464,625	11,744,250
	27,810,000		40,105,750	67,915,750	67,915,750

**NET DEBT SERVICE**

**MUEGGE FARMS METROPOLITAN DISTRICTS 1-8  
GENERAL OBLIGATION BONDS, SERIES 2026  
55.664 (target) Mills  
Non-Rated, 100x, 2056 Final Maturity  
[ Preliminary -- for discussion only ]**

<b>Period Ending</b>	<b>Principal</b>	<b>Interest</b>	<b>Total Debt Service</b>	<b>Debt Service Reserve</b>	<b>Capitalized Interest Fund</b>	<b>Net Debt Service</b>
12/01/2027		1,390,500	1,390,500		1,390,500	
12/01/2028		1,390,500	1,390,500		1,390,500	
12/01/2029		1,390,500	1,390,500		1,390,500	
12/01/2030		1,390,500	1,390,500			1,390,500
12/01/2031		1,390,500	1,390,500			1,390,500
12/01/2032		1,390,500	1,390,500			1,390,500
12/01/2033		1,390,500	1,390,500			1,390,500
12/01/2034		1,390,500	1,390,500			1,390,500
12/01/2035		1,390,500	1,390,500			1,390,500
12/01/2036		1,390,500	1,390,500			1,390,500
12/01/2037		1,390,500	1,390,500			1,390,500
12/01/2038		1,390,500	1,390,500			1,390,500
12/01/2039		1,390,500	1,390,500			1,390,500
12/01/2040		1,390,500	1,390,500			1,390,500
12/01/2041		1,390,500	1,390,500			1,390,500
12/01/2042		1,390,500	1,390,500			1,390,500
12/01/2043		1,390,500	1,390,500			1,390,500
12/01/2044		1,390,500	1,390,500			1,390,500
12/01/2045		1,390,500	1,390,500			1,390,500
12/01/2046	80,000	1,390,500	1,470,500			1,470,500
12/01/2047	80,000	1,386,500	1,466,500			1,466,500
12/01/2048	175,000	1,382,500	1,557,500			1,557,500
12/01/2049	185,000	1,373,750	1,558,750			1,558,750
12/01/2050	280,000	1,364,500	1,644,500			1,644,500
12/01/2051	300,000	1,350,500	1,650,500			1,650,500
12/01/2052	415,000	1,335,500	1,750,500			1,750,500
12/01/2053	430,000	1,314,750	1,744,750			1,744,750
12/01/2054	7,160,000	1,293,250	8,453,250			8,453,250
12/01/2055	7,520,000	935,250	8,455,250			8,455,250
12/01/2056	11,185,000	559,250	11,744,250	2,781,000		8,963,250
	<b>27,810,000</b>	<b>40,105,750</b>	<b>67,915,750</b>	<b>2,781,000</b>	<b>4,171,500</b>	<b>60,963,250</b>

**BOND SOLUTION**

**MUEGGE FARMS METROPOLITAN DISTRICTS 1-8  
GENERAL OBLIGATION BONDS, SERIES 2026**

**55.664 (target) Mills**

**Non-Rated, 100x, 2056 Final Maturity  
[ Preliminary -- for discussion only ]**

Period Ending	Proposed Principal	Proposed Debt Service	Debt Service Adjustments	Existing Debt Service	Total Adj Debt Service	Revenue Constraints	Unused Revenues	Debt Serv Coverage
12/01/2027		1,390,500	-1,390,500	3,159,000	3,159,000	3,053,911	-105,089	96.67335%
12/01/2028		1,390,500	-1,390,500	3,256,000	3,256,000	3,595,467	339,467	110.42588%
12/01/2029		1,390,500	-1,390,500	3,258,000	3,258,000	3,882,682	624,682	119.17380%
12/01/2030		1,390,500		3,354,500	4,745,000	4,203,253	-541,747	88.58278%
12/01/2031		1,390,500		3,355,750	4,746,250	4,203,253	-542,997	88.55945%
12/01/2032		1,390,500		3,476,250	4,866,750	4,455,448	-411,302	91.54874%
12/01/2033		1,390,500		3,475,000	4,865,500	4,455,448	-410,052	91.57226%
12/01/2034		1,390,500		3,687,750	5,078,250	4,722,775	-355,475	93.00005%
12/01/2035		1,390,500		3,683,750	5,074,250	4,722,775	-351,475	93.07336%
12/01/2036		1,390,500		3,908,250	5,298,750	5,006,142	-292,608	94.47779%
12/01/2037		1,390,500		3,904,750	5,295,250	5,006,142	-289,108	94.54023%
12/01/2038		1,390,500		4,139,000	5,529,500	5,306,510	-222,990	95.96727%
12/01/2039		1,390,500		4,139,000	5,529,500	5,306,510	-222,990	95.96727%
12/01/2040		1,390,500		4,390,750	5,781,250	5,624,901	-156,349	97.29558%
12/01/2041		1,390,500		4,391,500	5,782,000	5,624,901	-157,099	97.28296%
12/01/2042		1,390,500		4,653,000	6,043,500	5,962,395	-81,105	98.65798%
12/01/2043		1,390,500		4,652,000	6,042,500	5,962,395	-80,105	98.67430%
12/01/2044		1,390,500		4,930,750	6,321,250	6,320,139	-1,111	99.98242%
12/01/2045		1,390,500		4,935,000	6,325,500	6,320,139	-5,361	99.91524%
12/01/2046	80,000	1,470,500		5,227,500	6,698,000	6,699,347	1,347	100.02011%
12/01/2047	80,000	1,466,500		5,228,500	6,695,000	6,699,347	4,347	100.06493%
12/01/2048	175,000	1,557,500		5,541,500	7,099,000	7,101,308	2,308	100.03251%
12/01/2049	185,000	1,558,750		5,540,500	7,099,250	7,101,308	2,058	100.02898%
12/01/2050	280,000	1,644,500		5,877,865	7,522,365	7,527,386	5,022	100.06675%
12/01/2051	300,000	1,650,500		5,873,000	7,523,500	7,527,386	3,886	100.05165%
12/01/2052	415,000	1,750,500		6,227,500	7,978,000	7,979,029	1,029	100.01290%
12/01/2053	430,000	1,744,750		6,229,198	7,973,948	7,979,029	5,081	100.06372%
12/01/2054	7,160,000	8,453,250		8,453,250	8,453,250	8,457,771	4,521	100.05348%
12/01/2055	7,520,000	8,455,250		8,455,250	8,455,250	8,457,771	2,521	100.02982%
12/01/2056	11,185,000	11,744,250	-2,781,000		8,963,250	8,965,237	1,987	100.02217%
	<b>27,810,000</b>	<b>67,915,750</b>	<b>-6,952,500</b>	<b>120,495,563</b>	<b>181,458,813</b>	<b>178,230,105</b>	<b>-3,228,708</b>	

**EXHIBIT E**

**List of Public Improvements and Costs of Public Improvements**

2/10/2020 11:17 PM X:\18-131 MUEGGE FARMS\18-131 METRO DISTRICT\METRO DISTRICT 1 - COST ESTIMATE.DWG

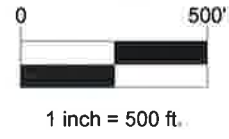
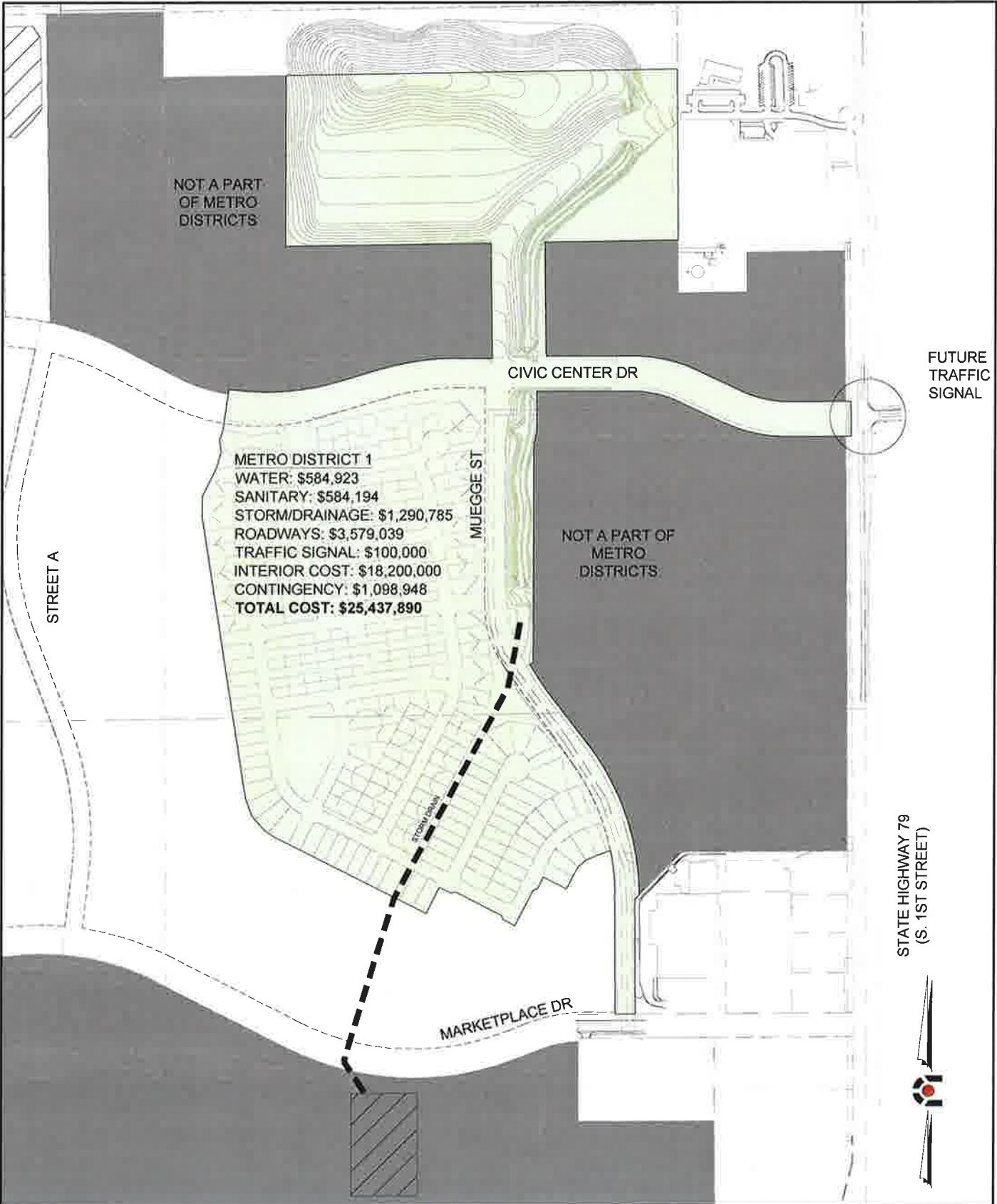

**MUEGGE FARMS**  
 METROPOLITAN DISTRICT 1  
 COST ESTIMATE

CREATED BY: BAB      DATE: 02/13/2020

SHEET NUMBER  
**1**  
 OF 1 SHEETS

JOB NUMBER  
 18-131



FUTURE TRAFFIC SIGNAL

TOWN OF BENNETT

E. COLFAX AVE

METRO DISTRICTS 2-8  
 WATER: \$1,439,630  
 SANITARY: \$2,174,537  
 STORM/DRAINAGE: \$7,096,371  
 ROADWAYS: \$5,192,573  
 TRAFFIC SIGNAL: \$2,127,189  
 INTERIOR COST: \$73,300,000  
 PARK: \$3,000,000  
 CONTINGENCY: \$2,559,320  
**TOTAL COST: \$96,889,620**

POND (TYP)

CIVIC CENTER DR

NOT A PART OF METRO DISTRICTS

FUTURE TRAFFIC SIGNAL

NOT A PART OF METRO DISTRICTS

- INITIAL BOUNDARY DISTRICT NO. 4
- INITIAL BOUNDARY DISTRICT NO. 5
- INITIAL BOUNDARY DISTRICT NO. 6
- INITIAL BOUNDARY DISTRICT NO. 7
- INITIAL BOUNDARY DISTRICT NO. 8

STREET B

MARKETPLACE DR

STREET A

MUEGGE ST

STATE HIGHWAY 79 (S. 1ST STREET)

POND (TYP)

INITIAL BOUNDARY DISTRICT NO. 3

MARKETPLACE DR

NOT A PART OF METRO DISTRICTS

I-70

**LEGEND**

-  METRO BOUNDARY
-  INCLUSION AREA



21/0000 1.21 PM, A:\18-131 MUEGGE FARMS\02-13-20\18-131 METRO DISTRICTS\METRO DISTRICTS 2-8 - COST ESTIMATE.DWG



**MUEGGE FARMS**  
 METROPOLITAN DISTRICT 2-8  
 COST ESTIMATE

CREATED BY: BAB      DATE: 02/13/2020

SHEET NUMBER  
**1**  
 OF 1 SHEETS

JOB NUMBER  
 18-131

**AMENDED AND RESTATED INTERGOVERNMENTAL AGREEMENT  
BETWEEN  
THE TOWN OF BENNETT COLORADO  
AND  
MUEGGE FARMS METROPOLITAN DISTRICTS 1, 2, 3, AND 4**

THIS AGREEMENT is made and entered into by and between the **TOWN OF BENNETT**, a municipal corporation of the State of Colorado (the “**Town**”), and **MUEGGE FARMS METROPOLITAN DISTRICTS 1, 2, 3, AND 4**, quasi-municipal corporations and political subdivisions of the State of Colorado (the “**Districts**”).

**RECITALS**

WHEREAS, the Districts were organized to provide those services and to exercise powers as are more specifically set forth in the Districts’ Amended and Restated Service Plan dated \_\_\_\_\_, 20\_\_\_\_, as amended from time to time by Town approval (the “**Service Plan**”); and

WHEREAS, the Service Plan and Section 16-20-60 of the Town Code requires the execution of an intergovernmental agreement between the Town and the Districts; and

WHEREAS, the Town and the Districts are authorized by Section 29-1-203, C.R.S., to enter into cooperative agreements for the sharing of costs, imposition of taxes, or incurring of debt, if such agreements are authorized by each party thereto with the approval of its legislative body; and

WHEREAS, the Town and the Districts previously entered into that certain Intergovernmental Agreement dated January 1, 2019 (the “**Original IGA**”); and

WHEREAS, the Town and the Districts wish to amend and restate in its entirety the Original IGA; and

WHEREAS, the Town and the Districts have determined it to be in their best interests to enter into this Intergovernmental Agreement (“**Agreement**”).

NOW, THEREFORE, for and in consideration of the covenants and mutual agreements herein contained, and for other good and valuable consideration, the receipt and sufficiency of which are hereby acknowledged, the parties hereto agree as follows:

**COVENANTS AND AGREEMENTS**

1. Incorporation by Reference. The Service Plan and Article XX of Chapter 16 of the Town Code (the “**Special District Code**”) are hereby incorporated in this Agreement by this reference. The Districts agree to comply with all provisions of the Service Plan and the Special District Code.

2. Enforcement. The parties agree that this Agreement may be enforced in law or in equity for specific performance, injunctive, or other appropriate relief. The parties also agree that this Agreement may be enforced pursuant to Section 32-1-207, C.R.S., and other provisions of Title 32, Article 1, C.R.S., granting rights to municipalities or counties approving a service plan of a special district.

3. Entire Agreement of the Parties. This Agreement constitutes the entire agreement between the parties and supersedes all prior written or oral agreements, negotiations, or representations and understandings of the parties with respect to the subject matter contained herein.

4. Amendment. This Agreement may be amended, modified, changed, or terminated in whole or in part only by a written agreement duly authorized and executed by the parties hereto.

5. Governing Law; Venue. The internal laws of the State of Colorado shall govern the interpretation and enforcement of this Agreement, without giving effect to choice of law or conflict of law principles. The parties hereby submit to the jurisdiction of and venue in the district court in Adams County, Colorado. In any proceeding brought to enforce the provisions of this Agreement, the prevailing party therein shall be entitled to an award of reasonable attorneys' fees, actual court costs and other expenses incurred.

6. Beneficiaries. Except as otherwise stated herein, this Agreement is intended to describe the rights and responsibilities of and between the named parties and is not intended to, and shall not be deemed to, confer any rights upon any persons or entities not named as parties.

7. Effect of Invalidity. If any portion of this Agreement is held invalid or unenforceable for any reason by a court of competent jurisdiction as to either party or as to both parties, such portion shall be deemed severable and its invalidity or its unenforceability shall not cause the entire agreement to be terminated.

8. Assignability. Neither the Town nor the Districts shall assign their rights or delegate their duties hereunder without the prior written consent of the other party.

9. Notices. All notices, certificates or other communications hereunder shall be sufficiently given and shall be deemed given when given by hand delivery, overnight delivery, mailed by certified or registered mail, postage prepaid, delivered electronically (if confirmed promptly telephonically) or dispatched by telegram or telecopy (if confirmed promptly telephonically), addressed to the following address or at such other address or addresses as any party hereto shall designate in writing to the other party hereto:

Town of Bennett  
207 Muegge Way  
Bennett, Colorado 80102  
Attention: Town Administrator

Muegge Metropolitan District Nos. 1-4  
c/o McGeady Becher P.C.



450 East 17<sup>th</sup> Avenue, Suite 400  
Denver, CO 80203  
Attn: MaryAnn McGeady

1. Successors and Assigns. This Agreement and the rights and obligations created hereby shall be binding upon and inure to the benefit of the parties hereto and their respective successors and assigns.

**MUEGGE METROPOLITAN DISTRICT  
NO. 1**

By: \_\_\_\_\_  
President

Attest:

\_\_\_\_\_  
Secretary

**MUEGGE METROPOLITAN DISTRICT  
NO. 2**

By: \_\_\_\_\_  
President

Attest:

\_\_\_\_\_  
Secretary

**MUEGGE METROPOLITAN DISTRICT  
NO. 3**

By: \_\_\_\_\_  
President

Attest:

\_\_\_\_\_  
Secretary

**MUEGGE METROPOLITAN DISTRICT  
NO. 4**

By: \_\_\_\_\_  
President

Attest:

\_\_\_\_\_  
Secretary

**TOWN OF BENNETT, COLORADO**

By: \_\_\_\_\_  
Mayor

Attest:

\_\_\_\_\_  
Town Clerk

**EXHIBIT 2**

**Affidavit of Publication**

PUBLISHER'S AFFIDAVIT

STATE OF COLORADO )SS
COUNTY OF ADAMS

I, Douglas Claussen, Publisher & Editor, or

[Signature] designated agent of the Eastern Colorado News, a weekly newspaper, printed and published in the County of Adams and State of Colorado, do hereby certify that the foregoing notice was published in said newspaper, published in the regular and entire issue of said newspaper, once each week for successive weeks; that the first publication of said notice was in the issue of said newspaper date:

2/28/2020

and the last publication of said notice was in the issue of said newspaper date:

2/28/2020

and that copies of each number of said paper in which said notice and/or list(s) were published, and delivered by carriers or transmitted by mail to each of the subscribers of said paper, according to the accustomed mode of business in this office.

[Signature] Agent Publisher/Editor

The above certificate of publication was subscribed and affirmed to before me, a Notary Public, to be the identical person described in the above certificate, on the 5th day of March, 2020

[Signature] Notary Public

04-16-2022 (My Commission Expires - Date)

NOTICE OF PUBLIC HEARING
NOTICE is hereby given pursuant to Section 32-1-204(1), C.R.S., that on Tuesday, March 24, 2020, at 7:00 p.m., or as soon as possible thereafter, a public hearing will be conducted. The hearing will be conducted at the Shared Services Center, 207 Muegge Way, Bennett, Colorado, or at such other time and place as this hearing may be continued. The Amended and Restated Service Plan for Muegge Farms Metropolitan District Nos. 1, 2, 3 and 4 may be examined at the Town Center Building. A public hearing will be heard upon the application on file with the Town of Bennett Board of Trustees, by the Board of Directors of Muegge Farms Metropolitan District Nos. 1, 2, 3 and 4, for approval of an Amended and Restated Service Plan (hereinafter referred to as the "Amended and Restated Service Plan"). The affected property is generally located Southwest of the intersection of East Colfax and South 1st Street, in the Town of Bennett, in Adams County, Colorado.
NOTICE IS FURTHER GIVEN that pursuant to Sections 32-1-203 (3.5) and 32-1-204 (1.5), C.R.S., the owner of real property within the Districts may file a request with the Town of Bennett Board of Trustees, requesting that such real property be excluded from the Districts. Such request may be filed any time after the Amended and Restated Service Plan is filed with the Town of Bennett Board of Trustees, but no later than ten (10) days before the day fixed for the hearing on said Amended and Restated Service Plan.
All protests and objections to the Amended and Restated Service Plan shall be deemed to be waived unless submitted in writing to the Town of Bennett Board of Trustees at or prior to the hearing or any continuance or postponement thereof in order to be considered.
Reason: Approval of an Amended and Restated Service Plan for Title 32 Special Districts
Project Name: Muegge Farms Metropolitan District Nos. 1, 2, 3 and 4
Date of Application: February 24, 2020
Type of District: Metropolitan
Published in The I-70 Scour February 25, 2020 and Eastern Colorado News February 28, 2020.

KEVIN HEMPHILL
Notary Public
State of Colorado
Notary ID # 20184016470
My Commission Expires 04-16-2022

**EXHIBIT 3**

**Certificate of Mailing of Notice of Hearing to Property Owners**

## NOTICE OF PUBLIC HEARING

NOTICE is hereby given pursuant to Section 32-1-204(1), C.R.S., that on Tuesday, March 24, 2020, at 7:00 p.m., or as soon as possible thereafter, a public hearing will be conducted. The hearing will be conducted at the Shared Services Center, 207 Muegge Way, Bennett, Colorado, or at such other time and place as this hearing may be continued. The proposed Amended and Restated Service Plan for Muegge Farms Metropolitan District Nos. 1, 2, 3 and 4 may be examined at the Town Center Building. A public hearing will be heard upon the application on file with the Town of Bennett Board of Trustees, by the Board of Directors of Muegge Farms Metropolitan District Nos. 1, 2, 3 and 4, for approval of an Amended and Restated Service Plan (hereinafter referred to as the "Amended and Restated Service Plan"). The affected property is generally located Southwest of the intersection of East Colfax and South 1<sup>st</sup> Street, in the Town of Bennett, in Adams County, Colorado.

NOTICE IS FURTHER GIVEN that pursuant to Sections 32-1-203 (3.5) and 32-1-204 (1.5), C.R.S., the owner of real property within the Districts may file a request with the Town of Bennett Board of Trustees, requesting that such real property be excluded from the Districts. Such request may be filed any time after the Amended and Restated Service Plan is filed with the Town of Bennett Board of Trustees, but no later than ten (10) days before the day fixed for the hearing on said Amended and Restated Service Plan.

All protests and objections to the Amended and Restated Service Plan shall be deemed to be waived unless submitted in writing to the Town of Bennett Board of Trustees at or prior to the hearing or any continuance or postponement thereof in order to be considered.

Reason:	Approval of an Amended and Restated Service Plan for Title 32 Special Districts
Project Name:	Muegge Farms Metropolitan District Nos. 1, 2, 3 and 4
Maximum Mill Levy – Debt:	55.277 mills
Maximum Mill Levy – Operations and Maintenance:	11.056 mills
Maximum Mill Levy for all Purposes:	66.333 mills. If the total amount of aggregate debt of a District is equal to or less than fifty percent (50%) of that District's assessed valuation.
Date of Application:	February 24, 2020
Type of District:	Metropolitan
Published In:	I-70 Scout February 25, 2020 Eastern Colorado News February 28, 2020

**CERTIFICATE OF MAILING**

I hereby certify that on February 28, 2020, a true and correct copy of the foregoing Notice of Public Hearing on the proposed Amended and Restated Service Plan for Muegge Farms Metropolitan District Nos. 1, 2, 3 and 4 was sent via regular mail to the person(s) and/or entities named on **Exhibit A** attached hereto.

**McGeady Becher P.C.**

By: /s/ Leslie Larsen  
Paralegal

**EXHIBIT A**

Mailing List

**ALL INTERESTED PARTIES/3-MILE RADIUS PARTIES**

Division of Local Government  
1313 Sherman St., Suite 521  
Denver, CO 80203

Adams County  
Board of County Commissioners  
4430 S Adams County Parkway  
Brighton, CO 80601

Rangeview Library District  
Attn: Nan Fisher  
5877 E. 120<sup>th</sup> Avenue  
Thornton, CO 80602

City of Aurora Planning &  
Development Services  
Attn: Andrea Amonick  
15151 E. Alameda Parkway, Ste. 2300  
Aurora, CO 80012

Town of Bennett  
Town Clerk  
207 Muegge Way  
Bennett, CO 80102

Bennett Fire District 7  
355 4<sup>th</sup> Street  
Bennett, CO 80102

Lost Creek Ground Water  
Attn: Tom Sauter  
50005 E. 120<sup>th</sup> Avenue  
Bennett, CO 80102

North Kiowa Bijou Ground Water  
Attn: Andrew F. McClary  
507 Water Street  
Fort Morgan, CO 80701



Bennett School District 29  
Attn: Superintendent  
615 7<sup>th</sup> Street  
Bennett, CO 80102

Urban Drainage South Platte  
Attn: Paul A. Hindman, Executive Director  
2480 W. 26<sup>th</sup> Avenue, Ste. 156-B  
Denver, CO 80211

Urban Drainage & Flood Control  
Attn: Paul A. Hindman, Executive Director  
2480 W. 26<sup>th</sup> Avenue, Ste. 156-B  
Denver, CO 80211

Bennett Park and Recreation  
c/o Collins Cockrel & Cole  
390 Union Boulevard, Ste. 400  
Denver, CO 80228-1556

Penrith Park General Improvement District  
Town Clerk, Town of Bennett  
355 4<sup>th</sup> Street  
Bennett, CO 80102

Transport Metro District No. 2  
White Bear Ankele  
2154 E. Commons Avenue, Ste. 2000  
Centennial, CO 80122

Bennett Crossing Metro District Nos. 1-3  
Miller & Associates LLC  
1641 California Street, Ste. 300  
Denver, CO 80202

Penrith Park Metro District  
Special District Solutions Inc.  
2370 Antelope Ridge Trail  
Parker, CO 80138

Section 27 Metro District  
McGeady Becher PC  
450 E. 17<sup>th</sup> Avenue, Suite 400  
Denver, CO 80203-1254

Muegge Farms Metro District Nos. 1-4  
Special District Solutions Inc.  
2370 Antelope Ridge Trail  
Parker, CO 80138

Rocky Mountain Rail Park Metro District  
Pinnacle Consulting Group Inc.  
6950 E. Belleview Avenue, Ste. 200  
Greenwood Village, CO 80111

Arapahoe County  
5334 S. Prince Street  
Littleton, CO 80120

Developmental Disability  
Attn: Todd Weaver  
5334 S. Prince Street  
Littleton, CO 80120

Arapahoe County L.E.A.  
Attn: Todd Weaver  
5334 S. Prince Street  
Littleton, CO 80120

Arapahoe Library District  
Attn: Executive Director  
12855 E. Adam Aircraft Circle  
Englewood, CO 80112

Antelope Hills General IMP District  
Attn: Trish Stiles  
355 4th Street.  
Bennett, CO 80102

Bennett Fire Protection District  
Attn: Lani Lee  
825 Shari's Court  
Bennett, CO 80102

Deer Trail Conservation District  
Attn: Sheryl Wailes  
133 W. Bijou Avenue  
Byers, CO 80103

Lost Creek Water Management District  
Attn: Office Manager  
50005 E 120th Avenue  
Bennett, CO 80102

North Kiowa Bijou Water District  
Attn: Andrew McClary  
507 Warner  
Fort Morgan, CO 80701

Strasburg Fire District  
Attn: District Clerk  
P.O. Box 911  
Strasburg, CO 80136

West Arapahoe Conservation District  
Attn: Tasha Chevarria  
133 W. Bijou Avenue  
Byers, CO 80103

**PROPERTY OWNER**

Muegge Farms LLC  
Attn: Dan Watts  
2835 S. Williams Street  
Denver, CO 80218-6334

**EXHIBIT 4**

**Certificate of Mailing of Notice of Hearing to Three Mile Radius Entities**

## NOTICE OF PUBLIC HEARING

NOTICE is hereby given pursuant to Section 32-1-204(1), C.R.S., that on Tuesday, March 24, 2020, at 7:00 p.m., or as soon as possible thereafter, a public hearing will be conducted. The hearing will be conducted at the Shared Services Center, 207 Muegge Way, Bennett, Colorado, or at such other time and place as this hearing may be continued. The proposed Amended and Restated Service Plan for Muegge Farms Metropolitan District Nos. 1, 2, 3 and 4 may be examined at the Town Center Building. A public hearing will be heard upon the application on file with the Town of Bennett Board of Trustees, by the Board of Directors of Muegge Farms Metropolitan District Nos. 1, 2, 3 and 4, for approval of an Amended and Restated Service Plan (hereinafter referred to as the "Amended and Restated Service Plan"). The affected property is generally located Southwest of the intersection of East Colfax and South 1<sup>st</sup> Street, in the Town of Bennett, in Adams County, Colorado.

NOTICE IS FURTHER GIVEN that pursuant to Sections 32-1-203 (3.5) and 32-1-204 (1.5), C.R.S., the owner of real property within the Districts may file a request with the Town of Bennett Board of Trustees, requesting that such real property be excluded from the Districts. Such request may be filed any time after the Amended and Restated Service Plan is filed with the Town of Bennett Board of Trustees, but no later than ten (10) days before the day fixed for the hearing on said Amended and Restated Service Plan.

All protests and objections to the Amended and Restated Service Plan shall be deemed to be waived unless submitted in writing to the Town of Bennett Board of Trustees at or prior to the hearing or any continuance or postponement thereof in order to be considered.

Reason:	Approval of an Amended and Restated Service Plan for Title 32 Special Districts
Project Name:	Muegge Farms Metropolitan District Nos. 1, 2, 3 and 4
Maximum Mill Levy – Debt:	55.277 mills
Maximum Mill Levy – Operations and Maintenance:	11.056 mills
Maximum Mill Levy for all Purposes:	66.333 mills. If the total amount of aggregate debt of a District is equal to or less than fifty percent (50%) of that District's assessed valuation.
Date of Application:	February 24, 2020
Type of District:	Metropolitan
Published In:	I-70 Scout February 25, 2020 Eastern Colorado News February 28, 2020

**CERTIFICATE OF MAILING**

I hereby certify that on February 28, 2020, a true and correct copy of the foregoing Notice of Public Hearing on the proposed Amended and Restated Service Plan for Muegge Farms Metropolitan District Nos. 1, 2, 3 and 4 was sent via regular mail to the person(s) and/or entities named on **Exhibit A** attached hereto.

**McGeady Becher P.C.**

By: /s/ Leslie Larsen  
Paralegal

**EXHIBIT A**

Mailing List

**ALL INTERESTED PARTIES/3-MILE RADIUS PARTIES**

Division of Local Government  
1313 Sherman St., Suite 521  
Denver, CO 80203

Adams County  
Board of County Commissioners  
4430 S Adams County Parkway  
Brighton, CO 80601

Rangeview Library District  
Attn: Nan Fisher  
5877 E. 120<sup>th</sup> Avenue  
Thornton, CO 80602

City of Aurora Planning &  
Development Services  
Attn: Andrea Amonick  
15151 E. Alameda Parkway, Ste. 2300  
Aurora, CO 80012

Town of Bennett  
Town Clerk  
207 Muegge Way  
Bennett, CO 80102

Bennett Fire District 7  
355 4<sup>th</sup> Street  
Bennett, CO 80102

Lost Creek Ground Water  
Attn: Tom Sauter  
50005 E. 120<sup>th</sup> Avenue  
Bennett, CO 80102

North Kiowa Bijou Ground Water  
Attn: Andrew F. McClary  
507 Water Street  
Fort Morgan, CO 80701

Bennett School District 29  
Attn: Superintendent  
615 7<sup>th</sup> Street  
Bennett, CO 80102

Urban Drainage South Platte  
Attn: Paul A. Hindman, Executive Director  
2480 W. 26<sup>th</sup> Avenue, Ste. 156-B  
Denver, CO 80211

Urban Drainage & Flood Control  
Attn: Paul A. Hindman, Executive Director  
2480 W. 26<sup>th</sup> Avenue, Ste. 156-B  
Denver, CO 80211

Bennett Park and Recreation  
c/o Collins Cockrel & Cole  
390 Union Boulevard, Ste. 400  
Denver, CO 80228-1556

Penrith Park General Improvement District  
Town Clerk, Town of Bennett  
355 4<sup>th</sup> Street  
Bennett, CO 80102

Transport Metro District No. 2  
White Bear Ankele  
2154 E. Commons Avenue, Ste. 2000  
Centennial, CO 80122

Bennett Crossing Metro District Nos. 1-3  
Miller & Associates LLC  
1641 California Street, Ste. 300  
Denver, CO 80202

Penrith Park Metro District  
Special District Solutions Inc.  
2370 Antelope Ridge Trail  
Parker, CO 80138

Section 27 Metro District  
McGeady Becher PC  
450 E. 17<sup>th</sup> Avenue, Suite 400  
Denver, CO 80203-1254



Muegge Farms Metro District Nos. 1-4  
Special District Solutions Inc.  
2370 Antelope Ridge Trail  
Parker, CO 80138

Rocky Mountain Rail Park Metro District  
Pinnacle Consulting Group Inc.  
6950 E. Belleview Avenue, Ste. 200  
Greenwood Village, CO 80111

Arapahoe County  
5334 S. Prince Street  
Littleton, CO 80120

Developmental Disability  
Attn: Todd Weaver  
5334 S. Prince Street  
Littleton, CO 80120

Arapahoe County L.E.A.  
Attn: Todd Weaver  
5334 S. Prince Street  
Littleton, CO 80120

Arapahoe Library District  
Attn: Executive Director  
12855 E. Adam Aircraft Circle  
Englewood, CO 80112

Antelope Hills General IMP District  
Attn: Trish Stiles  
355 4th Street  
Bennett, CO 80102

Bennett Fire Protection District  
Attn: Lani Lee  
825 Shari's Court  
Bennett, CO 80102

Deer Trail Conservation District  
Attn: Sheryl Wailes  
133 W. Bijou Avenue  
Byers, CO 80103

Lost Creek Water Management District  
Attn: Office Manager  
50005 E 120th Avenue  
Bennett, CO 80102

North Kiowa Bijou Water District  
Attn: Andrew McClary  
507 Warner  
Fort Morgan, CO 80701

Strasburg Fire District  
Attn: District Clerk  
P.O. Box 911  
Strasburg, CO 80136

West Arapahoe Conservation District  
Attn: Tasha Chevarria  
133 W. Bijou Avenue  
Byers, CO 80103

**PROPERTY OWNER**

Muegge Farms LLC  
Attn: Dan Watts  
2835 S. Williams Street  
Denver, CO 80218-6334